

HeartStart HSI Defibrillators

TECHNICAL REFERENCE MANUAL

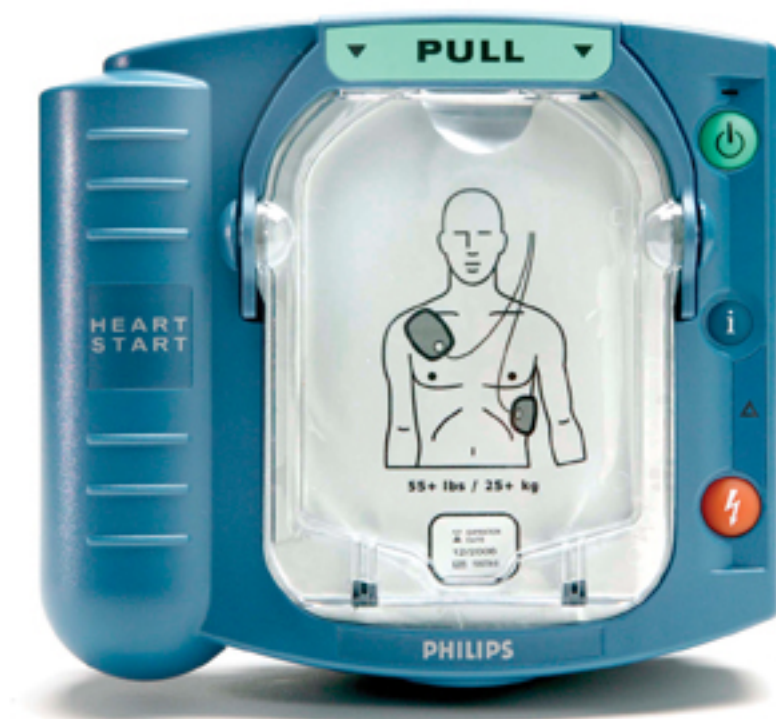

PHILIPS

About this edition

The information in this guide applies to all models in the HeartStart HSI family of defibrillators, including the HeartStart, the HeartStart OnSite, the HeartStart Home, and the HeartStart First Aid Defibrillator. This information is subject to change. Please contact Philips at www.philips.com/productdocs or your local Philips representative for information on revisions.

Edition history

Edition 4

Publication date: September 2014

Publication #: 45356430245 I

Notices

© 2014 Koninklijke Philips N.V. All rights reserved.
Specifications are subject to change without notice.
Trademarks are the property of Koninklijke Philips N.V. or their respective owners.

Authorized EU representative

Philips Medizin Systeme Boeblingen GmbH
Hewlett-Packard Strasse 2
71034 Boeblingen, Germany
(+49) 7031 463-2254

Device manufacturer

Philips Medical Systems, Bothell, WA 98021-8431, USA

Patents

This product is manufactured and sold under one or more of the following United States patents:

US5591213, US5601612, US5607454, US5611815, US5617853, US5632280, US5650750, US5735879, US5749905, US5773961, US5776166, US5800460, US5803927, US5868792, US5879374, US5889388, US5891046, US5891049, US5899926, US5902249, US5904707, US5951598, US6016059, US6047212, US6075369, US6185458, US6230054, US6287328, US6299574, US6317635, US6356785, US6417649, US6441582, US6553257, US6556864, US6662056, US6871093, US7463922, US7489972, US7689278, US7715913, US7822488, US8086306, US8209008, US8335562, USRE43050 and other patents pending.

CONTENTS

I	THE HEARTSTART HSI DEFIBRILLATORS	
	Sudden cardiac arrest and the AED	1-1
	Design philosophy for the HSI Defibrillators	1-1
	Design features of the HSI AEDs	1-2
	Reliability and Safety	1-2
	Ease of Use	1-3
	No Maintenance	1-4
2	DEFIBRILLATION AND ELECTRICITY	
	The Heart's Electrical System	2-1
	Simplifying Electricity	2-4
3	SMART BIPHASIC WAVEFORM	
	A Brief History of Defibrillation	3-1
	SMART Biphasic	3-4
	Understanding Fixed Energy	3-5
	Evidence-Based Support for the SMART Biphasic Waveform	3-6
	SMART Biphasic Superior to Monophasic	3-6
	Key Studies	3-7
	Frequently Asked Questions	3-8
	Are all biphasic waveforms alike?	3-8
	How can the SMART Biphasic waveform be more effective at lower energy?	3-9
	Is escalating energy required?	3-10
	Is there a relationship between waveform, energy level, and post-shock dysfunction?	3-13
	How does SMART Biphasic compare to other biphasic waveforms?	3-15
	Is there a standard for biphasic energy levels?	3-15
	Commitment to SMART Biphasic	3-16
	References	3-17
4	SMART ANALYSIS	
	Pad Contact Quality	4-1
	Artifact Detection	4-1
	Overview	4-1
	CPR at High Rates of Compression	4-2
	Pacemaker Detection	4-2

Arrhythmia Detection	4-4
Rate	4-5
Conduction	4-5
Stability	4-6
Amplitude	4-7
Specific Analysis Examples	4-7
Sensitivity and Specificity	4-10
Shockable Rhythms	4-11
Validation of Algorithm	4-14
Specific Concerns for Advanced Users of HeartStart AEDs	4-15
HeartStart AED vs. HeartStart ALS Defibrillator Algorithms	4-15
Simulator Issues with SMART Analysis	4-15
Use of External Pacemakers with Internal Leads	4-16

5 OTHER FEATURES

Overview	5-1
Self-Tests	5-1
Battery Insertion Test	5-1
Ready Light	5-1
Periodic Self-Tests	5-2
Cumulative Device Record	5-5
Supplemental Maintenance Information for Technical Professionals	5-5
Background	5-5
Calibration requirements and intervals	5-6
Maintenance testing	5-6
Verification of energy discharge	5-6
Service/Maintenance and Repair Manual	5-6
CPR Coaching	5-6
Quick Shock	5-7
Pediatric Defibrillation	5-7
HeartStart Trainer	5-8
Training Scenarios	5-8

6	THEORY OF OPERATION	
	Overview	6-1
	User interface	6-3
	Operation	6-3
	Maintenance	6-3
	Troubleshooting	6-3
	Control Board	6-4
	Battery	6-4
	Power Supply	6-4
	ECG Front End	6-4
	Patient Circuit	6-4
	Data Recording	6-5
	Temperature Sensor	6-5
	Timer	6-6
	IR Port	6-6
7	DATA MANAGEMENT AND CONFIGURATION SOFTWARE	
	Overview	7-1
	System Requirements	7-3
	Comparison of Event Review and Event Review Pro	7-4
	System Annotations	7-5
	Technical Support for Data Management Software	7-6
	Configuration Software	7-7

APPENDICES

A Technical Specifications	
Standards Applied	A-1
HSI AED Specifications	A-2
Electromagnetic Conformity	A-6
Accessories Specifications	A-9
Environmental considerations	A-10
B Troubleshooting Information	
Routine Troubleshooting for the Heartstart HSI Defibrillator	B-1
Troubleshooting Steps	B-3
Verification of Energy Delivery	B-3
C Pads and Battery	
Defibrillator Pads for the HeartStart HSI AED	C-1
Defibrillator Pads Placement with HSI AED	C-2
Batteries for HSI AED	C-3
D Use Environment	
Defibrillation in the Presence of Oxygen	D-1
Defibrillation on a Wet or Metal Surface	D-1
Protection against Water and Particles	D-4
Effects of Extreme Environments	D-6
Self-Test Aborts Due to Temperature Extremes	D-7
E Guidelines 2005/2010	
F Literature Summary for HeartStart AEDs	
Introduction	F-1
References	F-2
Selected Study Summaries	F-16
HeartStart Low-Energy, High-Current Design	F-16
HeartStart Quick Shock Feature	F-18
HeartStart Human Factors Design	F-21
HeartStart Defibrillation Therapy Testing in Adult Victims of Out-of-Hospital Cardiac Arrest	F-24
HeartStart Patient Analysis System Testing with Pediatric Rhythms	F-26
HeartStart Defibrillation Therapy Testing in a Pediatric Animal Model	F-29

I THE HEARTSTART HSI DEFIBRILLATORS

SUDDEN CARDIAC ARREST AND THE AED

Each year in North America alone, approximately 350,000 people suffer sudden cardiac arrest (SCA).¹ Fewer than 5% of them survive. SCA is most often caused by an irregular heart rhythm called ventricular fibrillation (VF), for which the only effective treatment is defibrillation, an electrical shock. Often, a victim of SCA does not survive because of the time it takes to deliver the defibrillation shock. For every minute that passes between collapse and defibrillation, survival rates from witnessed VF SCA decrease 7% to 10% if no CPR is provided.² When bystander CPR is provided, the decrease in survival rates is more gradual and averages 3% to 4% per minute from collapse to defibrillation.

Traditionally, only trained medical personnel were allowed to use a defibrillator because of the high level of knowledge and training involved. Initially, this meant that the victim of SCA would have to be transported to a medical facility in order to be defibrillated. In 1969, paramedic programs were developed in several communities in the U.S. to act as an extension of the hospital emergency room. Paramedics went through extensive training to learn how to deliver emergency medical care outside the hospital, including training in defibrillation. In the early 1980s, some Emergency Medical Technicians (EMTs) were also being trained to use defibrillators to treat victims of SCA. However, even with these advances, in 1990 fewer than half of the ambulances in the United States carried a defibrillator, so the chances of surviving SCA outside the hospital or in communities without highly developed Emergency Medical Systems were still very small.

The development of the automated external defibrillator (AED) made it possible for the first responders (typically lay persons) at the scene to treat SCA with defibrillation. People trained to perform CPR can now use a defibrillator to defibrillate a victim of SCA. The result: victims of sudden cardiac arrest can be defibrillated more rapidly than ever before, and they have a better chance of surviving until more highly trained medical personnel arrive who can treat the underlying causes.

DESIGN PHILOSOPHY FOR THE HSI DEFIBRILLATORS

The Philips HeartStart HSI family of automated external defibrillators (AEDs) are sold in the United States as HeartStart OnSite and HeartStart Home, and internationally as HeartStart HSI, HeartStart Home, or HeartStart First Aid defibrillator.

1. American Heart Association. 2010 Guidelines for Cardiopulmonary Resuscitation and Emergency Cardiovascular Care Science. *Circulation* 2010;122[suppl 3].
2. *Ibid.*

The Philips HeartStart HSI automated external defibrillators (AEDs) are designed specifically for use by the first people responding to an emergency. They are reliable, easy to use, and virtually maintenance free. The design allows these AEDs to be used by people with no medical training in places where defibrillators have not traditionally been used. In fact, the HeartStart Home was the first AED cleared by the United States Food and Drug Administration for sale without a prescription.

Factors that had to be considered in their design included the fact that an AED might not be used very often, might be subjected to harsh environments, and probably would not have personnel available to perform regular maintenance.

The HSI AEDs were not designed to replace the manual defibrillators used by more highly trained individuals. Instead, they are intended to complement the efforts of medical personnel by allowing the initial shock to be delivered by the first person to arrive at the scene.



DESIGN FEATURES OF THE HSI AEDS

RELIABILITY AND SAFETY

- **FAIL-SAFE DESIGN** — The HSI AEDs are intended to detect a shockable rhythm and instruct the user to deliver a shock if needed. They will not allow a shock if one is not required.
- **DAILY AUTOMATIC SELF-TEST** — The HSI AEDs perform daily as well as weekly and monthly self-tests to help ensure they are ready to use when needed. An active LED Ready light serves as a status indicator and demonstrates at a glance that the unit has passed its last self-test and is therefore ready to use.
- **ENVIRONMENTAL PARAMETERS** — Environmental tests were conducted to prove the HSI AEDs' reliability and ability to operate in conditions relevant to expected use.
- **NON-RECHARGEABLE LITHIUM BATTERY** — The HSI long-life battery pack M5070A was designed for use in an emergency environment and is therefore small, lightweight, and safe to use. The battery pack contains multiple 2/3A size, standard lithium batteries. These same batteries can be purchased at local drug stores for use in other consumer products. These batteries have been proven to be reliable and safe over many years of operation. The HSI battery pack uses lithium manganese dioxide (Li/MnO₂) technology and does not contain pressurized sulfur dioxide. The battery pack meets the U.S. Environmental Protection Agency's Toxicity Characteristic Leaching Procedure. All battery cells contain chemicals and should be recycled at an appropriate recycling facility in accordance with local regulations.

- **QUICK SHOCK** — The HSI can deliver a defibrillation shock very quickly – typically within 8 seconds – after the end of a patient care pause.

EASE OF USE

- **SMALL AND LIGHT** — The biphasic waveform technology used in the HSI AEDs has allowed them to be small and light. They can easily be carried and operated by one person.
- **SELF-CONTAINED** — Both the standard and hard-shell carry cases for the HSI have room for an extra defibrillator Pads Cartridge and an extra battery.
- **VOICE PROMPTS** — The HSI AEDs provide clear, calm, audible prompts that guide the user through the process of using the device.
- **CPR COACHING** — In its default configuration, the HSI AEDs provide basic verbal instructions for performing cardiopulmonary resuscitation, including hand placement, rescue breathing, compression depth and timing, provided by the HSI when the flashing blue i-button is pressed during the first 30 seconds of a patient care pause. If the Infant/Child Pads Cartridge is inserted in the HSI, the CPR Coaching provided will be for infant/child CPR.
- **PRE-CONNECTED PADS** — The HSI uses a pre-installed HeartStart SMART Pads Cartridge. The HeartStart Infant/Child Pads Cartridge is designed for use in the event defibrillation is required for an infant or child under 55 pounds and 8 years old. The AED can be turned on by pulling the green Pads Cartridge handle, as well as by using the green On/Off button.
- **CAUTION LIGHT** — When the HSI is in use and is analyzing the patient's heart rhythm, a triangular Caution light on the front of the HSI flashes to alert the user not to touch the patient. When the HSI advises a shock, the Caution light stops flashing and stays on as a reminder not to touch the patient during shock delivery. 
- **I-BUTTON** — The HSI has a blue information button (i-button) on the front. When it is on solid (without flashing), it is an indicator that it is safe to touch the patient. When the button flashes the user can press it to get information such as summary data about the last use or (default) CPR Coaching. 
- **SHOCK BUTTON** — The orange Shock button on the front of the HSI bears a lightning bolt symbol to identify it. It flashes when the unit has charged for a shock and directs the user to press the button to deliver a shock by pressing the Shock button. 

- **CLEAR LABELING AND GRAPHICS** — The HSI AEDs are designed to enable fast response by the user. The 1-2-3 operation guides the user to: 1) turn the unit on, 2) follow the prompts, and 3) deliver a shock if instructed. A Quick Reference Card stored inside the carry case reinforces these instructions. The pads placement icon on the pads cartridge indicates clearly where pads should be placed, and the pads themselves are labeled to specify where each one should be placed. The polarity of the pads does not affect the operation of the AED, but user testing has shown that people apply the pads more quickly and accurately if a specific position is shown on each pad.

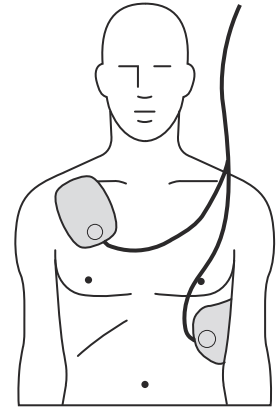

- **PROVEN ANALYSIS SYSTEM** — The SMART rhythm analysis system used in the HSI AEDs analyzes the patient's ECG rhythm and determines whether or not a shock should be administered. The algorithm's decision criteria allow the user to be confident that the HSI will advise a shock only when it is appropriate treatment for the patient.
- **ARTIFACT DETECTION SYSTEM** — An artifact detection system in the HSI AEDs senses if the ECG is being corrupted by some form of artifact from electrical "noise" in the surrounding environment, patient handling, or the activity of an implanted pacemaker. Because such artifact might inhibit or delay a shock decision, the HSI filters out the noise from the ECG, prompting the user to stop patient handling, or determining that the level of artifact does not pose a problem for the algorithm.
- **PADS DETECTION SYSTEM** — The HSI AEDs' pads detection system provides a voice prompt to alert the user if the pads are not making proper contact with the patient's skin.

NO MAINTENANCE

- **AUTOMATIC DAILY/WEEKLY/MONTHLY SELF-TESTS** — There is no need for calibration, energy verification, or manual testing with the HSI AEDs. Calibration and energy verification are automatically performed once a month as part of the HSI self-test routine.
- **ACTIVE STATUS INDICATOR** — The green LED Ready light in the upper right-hand corner of the HSI AED shows whether or not the device has passed its last self-test. When the Ready light is blinking, you can be confident that the device has passed its last self-test and is ready for use. A solid Ready light means the defibrillator is being used.
- **BATTERY LEVEL INDICATOR** — The HSI AEDs prompt the user with an audible alarm when the battery or pads cartridge need to be replaced.

THE HEART'S ELECTRICAL SYSTEM

The heart muscle, or myocardium, is a mass of muscle cells. Some of these cells (“working” cells) are specialized for contracting, which causes the pumping action of the heart. Other cells (“electrical system” cells) are specialized for conduction. They conduct the electrical impulses throughout the heart and allow it to pump in an organized and productive manner. All of the electrical activity in the heart is initiated in specialized muscle cells called “pacemaker” cells, which spontaneously initiate electrical impulses that are conducted through pathways in the heart made up of electrical system cells. Although autonomic nerves surround the heart and can influence the rate or strength of the heart’s contractions, it is the pacemaker cells, and not the autonomic nerves, that initiate the electrical impulses that cause the heart to contract.

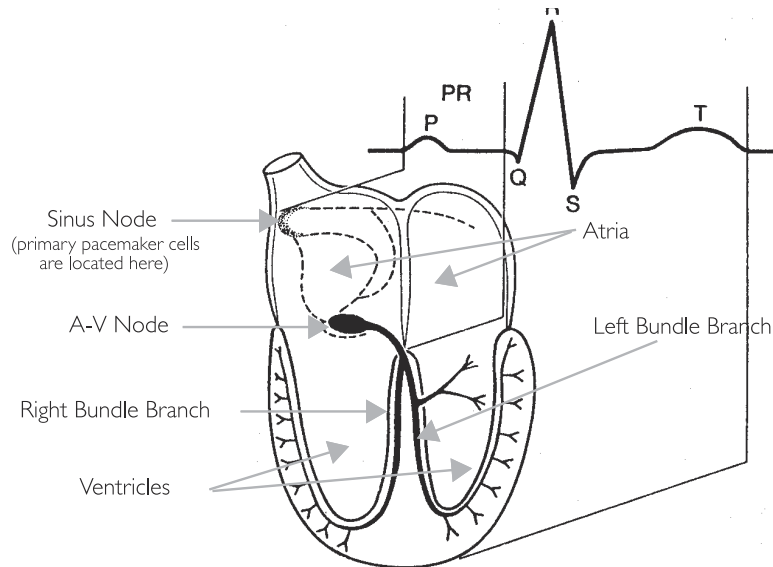

Relation of an ECG to the anatomy of the cardiac conduction system

The heart is made up of four chambers, two smaller, upper chambers called the atria, and two larger, lower chambers called the ventricles. The right atrium collects blood returning from the body and pumps it into the right ventricle. The right ventricle then pumps that blood into the lungs to be oxygenated. The left atrium collects the blood coming back from the lungs and pumps it into the left ventricle. Finally, the left ventricle pumps the oxygenated blood to the body, and the cycle starts over again.

The electrocardiogram (ECG) measures the heart's electrical activity by monitoring the small signals from the heart that are conducted to the surface of the patient's chest. The ECG indicates whether or not the heart is conducting the electrical impulses properly, which results in pumping blood throughout the body. In a healthy heart, the electrical impulse begins at the sinus node, travels down (propagates) to the A-V node, causing the atria to contract, and then travels down the left and right bundle branches before spreading out across the ventricles, causing them to contract in unison.

The “normal sinus rhythm” or NSR (so called because the impulse starts at the sinus node and follows the normal conduction path) shown below is an example of what the ECG for a healthy heart looks like.

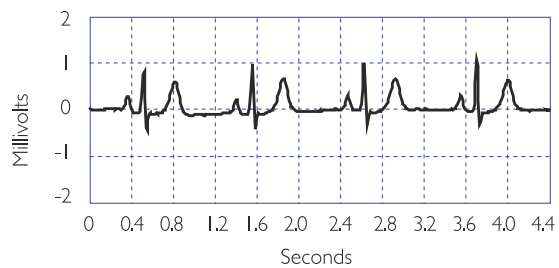

Normal sinus rhythm

Sudden cardiac arrest (SCA) occurs when the heart stops beating in an organized manner and is unable to pump blood throughout the body. A person stricken with SCA will lose consciousness and stop breathing within a matter of seconds. SCA is a disorder of the heart's electrical conduction pathway that prevents the heart from contracting in a manner that will effectively pump the blood.

Although the terms “heart attack” and “sudden cardiac arrest” are sometimes used interchangeably, they are actually two distinct and different conditions. A heart attack, or myocardial infarction (MI), refers to a physical disorder where blood flow is restricted to a certain area of the heart. This can be caused by a coronary artery that is obstructed with plaque and results in an area of tissue that doesn't receive any oxygen. This will eventually cause those cells to die if nothing is done. A heart attack is typically accompanied by pain, shortness of breath, and other symptoms, and is usually treated with drugs or angioplasty. Although sudden death is possible, it does not always occur. Many times, a heart attack will lead to SCA, which does lead to sudden death if no action is taken.

The most common heart rhythm in SCA is ventricular fibrillation (VF). VF refers to a condition that can develop when the working cells stop responding to the electrical system in the heart and start contracting randomly on their own. When this occurs, the heart becomes a quivering mass of muscle and loses its ability to pump blood through the body. The heart “stops beating”, and the person will lose consciousness and stop breathing within seconds. If defibrillation is not successfully performed to return the heart to a productive rhythm, the person will die within minutes. The ECG below depicts ventricular fibrillation.

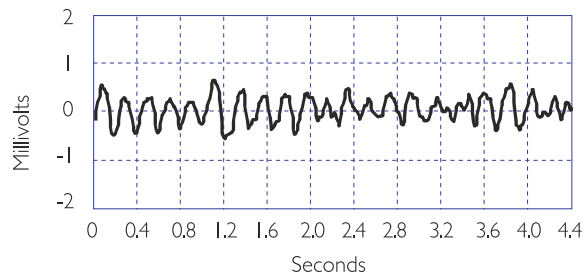

Ventricular fibrillation

Cardiopulmonary resuscitation, or CPR, allows some oxygen to be delivered to the various body organs (including the heart), but at a much-reduced rate. CPR will not stop fibrillation. However, because it allows some oxygen to be supplied to the heart tissue, CPR extends the length of time during which defibrillation is still possible. Even with CPR, a fibrillating heart rhythm will eventually degenerate into asystole, or “flatline,” which is the absence of any electrical activity. If this happens, the patient has almost no chance of survival.

Defibrillation is the use of an electrical shock to stop fibrillation and allow the heart to return to a regular, productive rhythm that leads to pumping action. The shock is intended to cause the majority of the working cells to contract (or “depolarize”) simultaneously. This allows them to start responding to the natural electrical system in the heart and begin beating in an organized manner again. The chance of survival decreases by about 10% for every minute the heart remains in fibrillation, so defibrillating someone as quickly as possible is vital to survival.

An electrical shock is delivered by a defibrillator, and involves placing two electrodes on a person's chest in such a way that an electrical current travels from one pad to the other, passing through the heart muscle along the way. Since the electrodes typically are placed on the patient's chest, the current must pass through the skin, chest muscles, ribs, and organs in the area of the chest cavity, in addition to the heart. A person will sometimes “jump” when a shock is delivered, because the same current that causes all the working cells in the heart to contract can also cause the muscles in the chest to contract.

SIMPLIFYING ELECTRICITY

Energy is defined as the capacity to do work, and electrical energy can be used for many purposes. It can drive motors used in many common household appliances, it can heat a home, or it can restart a heart. The electrical energy used in any of these situations depends on the level of the voltage applied, how much current is flowing, and for what period of time that current flows. The voltage level and the amount of current that flows are related by impedance, which is basically defined as the resistance to the flow of current.¹

If you think of voltage as water pressure and current as the flow of water out of a hose, then impedance is determined by the size of the hose. If you have a small garden hose, the impedance would be relatively large and would not allow much water to flow through the hose. If, on the other hand, you have a fire hose, the impedance would be lower, and much more water could flow through the hose given the same pressure. The volume of water that comes out of the hose depends on the pressure, the size of the hose, and the amount of time the water flows. A garden hose at a certain pressure for a short period of time works well for watering your garden, but if you used a fire hose with the same pressure and time, you could easily wash your garden away.

Electrical energy is similar. The amount of energy delivered depends on the voltage, the current, and the duration of its application. If a certain voltage is present across the defibrillator pads attached to a patient's chest, the amount of current that will flow through the patient's chest is determined by the impedance of the body tissue. The amount of energy delivered to the patient is determined by how long that current flows at that level of voltage.

In the case of the biphasic waveforms shown in the following pages, energy (E) is the power (P) delivered over a specified time (t), or $E = P \times t$.

1. Voltage is measured in volts, current is measured in amperes (amps), and impedance is measured in ohms. Large amounts of electrical energy are measured in kilowatt-hours, as seen on your electric bill. Small amounts can be measured in joules (J), which are watt-seconds.

Electrical power is defined as the voltage (V) times the current (volts= joules/coulomb, amps = coulombs/sec):	$P = V \times I$
From Ohm's law, voltage and current are related by resistance (R) (impedance):	$V = I \times R$ or $I = V/R$
Power is therefore related to voltage and resistance by:	$P = V^2/R$ or $P = I^2R$
Substituting this back into the equation for energy means that the energy delivered by the biphasic waveform is represented by:	$E = V^2/R \times t$ or $E = I^2R \times t$

In determining how effective the energy is at converting a heart in fibrillation, how the energy is delivered -- or the shape of the waveform (the value of the voltage over time) -- is actually more important than the amount of energy delivered.

For the SMART Biphasic waveform, the design strategy involved starting with a set peak voltage stored on the capacitor that will decay exponentially as current is delivered to the patient. The SMART Biphasic waveform shown here is displayed with the voltage plotted versus time, for a patient with an impedance of 75 ohms. By changing the time duration of the positive and negative pulses, the energy delivered to the patient can be controlled.

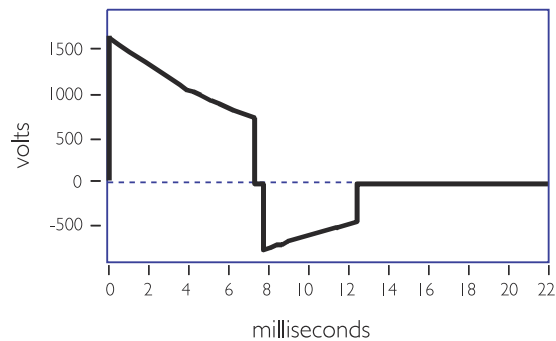

SMART Biphasic waveform

Although the relationship of voltage and energy is of interest in designing the defibrillator, it is actually the current that is responsible for defibrillating the heart.

The following three graphs demonstrate how the shape of the current waveform changes with different patient impedances. Once again, the SMART Biphasic waveform delivers the same amount of energy (150 J) to every patient, but the shape of the waveform changes to provide the highest level of effectiveness for defibrillating the patient at each impedance value.

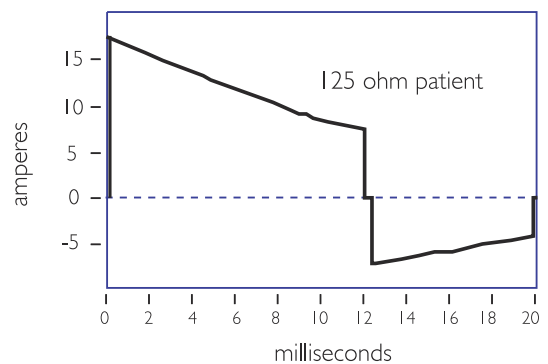
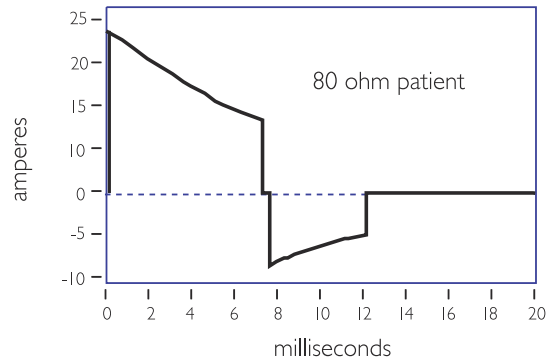
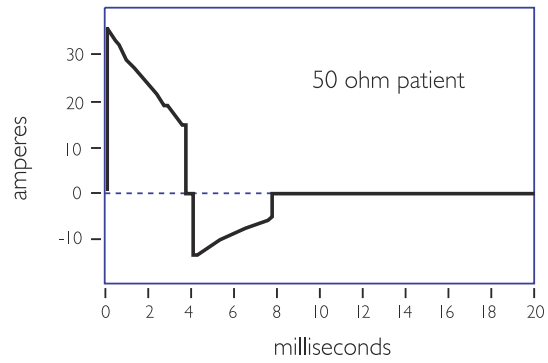

With the SMART Biphasic waveform, the shape of the waveform is optimized for each patient. The initial voltage remains the same, but the peak current will depend on the patient's impedance. The tilt (slope) and the time duration are adjusted for different patient impedances to maintain approximately 150 J for each shock. The phase ratio, or the relative amount of time the waveform spends in the positive pulse versus the negative pulse, is also adjusted depending upon the patient impedance to insure the waveform remains effective for all patients. Adjusting these parameters makes it easier to control the accuracy of the energy delivered since they are proportionally related to energy, whereas voltage is exponentially related to energy.

The HeartStart Defibrillator measures the patient's impedance during each shock. The delivered energy is controlled by using the impedance value to determine what tilt and time period are required to deliver 150 J.

The average impedance in adults is 75 ohms, but it can vary from 25 to 180 ohms. Because a HeartStart Defibrillator measures the impedance and adjusts the shape of the waveform accordingly, it delivers 150 J of energy to the patient every time the shock button is pressed. Controlling the amount of energy delivered allows the defibrillator to deliver enough energy to defibrillate the heart, but not more. Numerous studies have demonstrated that the waveform used by HeartStart Defibrillator is more effective in defibrillating out-of-hospital cardiac arrest patients than the waveforms used by conventional defibrillators. Moreover, the lower energy delivered results in less post-shock dysfunction of the heart, resulting in better outcomes for survivors.

3 SMART BIPHASIC WAVEFORM

Defibrillation is the only effective treatment for ventricular fibrillation, the most common cause of sudden cardiac arrest (SCA). The defibrillation waveform used by a defibrillator determines how energy is delivered to a patient and defines the relationship between the voltage, current, and patient impedance over time. The defibrillator waveform used is critical for defibrillation efficacy and patient outcome.

A BRIEF HISTORY OF DEFIBRILLATION

The concept of electrical defibrillation was introduced over a century ago. Early experimental defibrillators used 60 cycle alternating current (AC) household power with step-up transformers to increase the voltage. The shock was delivered directly to the heart muscle. Transthoracic (through the chest wall) defibrillation was first used in the 1950s.

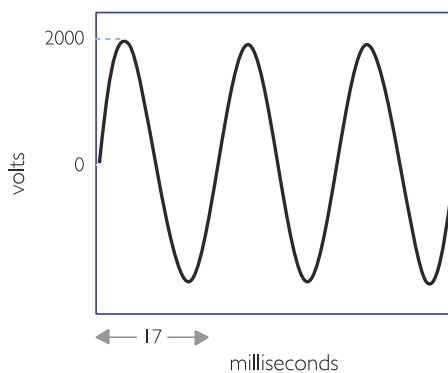

alternating current (AC) waveform

The desire for portability led to the development of battery-powered direct current (DC) defibrillators in the 1950s. At that time it was also discovered that DC shocks were more effective than AC shocks. The first “portable” defibrillator was developed at Johns Hopkins University. It used a biphasic waveform to deliver 100 joules (J) over 14 milliseconds. The unit weighed 50 pounds with accessories (at a time when standard defibrillators typically weighed more than 250 pounds) and was briefly commercialized for use in the electric utility industry.

Defibrillation therapy gradually gained acceptance over the next two decades. An automated external defibrillator (AED) was introduced in the mid-1970s, shortly before the first automatic internal cardioverter-defibrillator (AICD) was implanted in a human.

Historically, defibrillators used one of two types of monophasic waveforms: monophasic damped sine (MDS) or monophasic truncated exponential (MTE). With monophasic waveforms, the heart receives a single burst of electrical current that travels from one pad or paddle to the other.

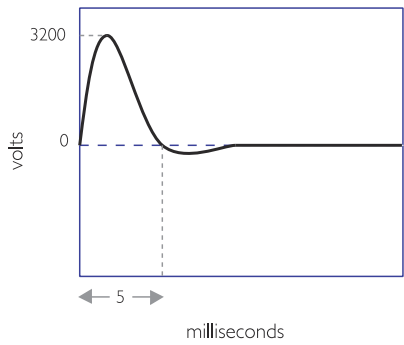

biphasic damped sine (MDS) waveform

The MDS waveform requires high energy levels, up to 360 J, to defibrillate effectively. MDS waveforms are not designed to compensate for differences in impedance — the resistance of the body to the flow of current — encountered in different patients. As a result, the effectiveness of the shock can vary greatly with the patient impedance.

Traditional MDS waveform defibrillators assume a patient impedance of 50 ohms, but the average impedance of adult humans is between 70 and 80 ohms. As a result, the actual energy delivered by MDS waveforms is usually higher than the selected energy.

The monophasic truncated exponential (MTE) waveform also uses energy settings of up to 360 J. Because it uses a lower voltage than the MDS waveform, the MTE waveform requires a longer duration to deliver the full energy to patients with higher impedances. This form of impedance compensation does not improve the efficacy of defibrillation, but simply allows extra time to deliver the selected energy. Long-duration shocks (> 20 msec) have been associated with reibrillation.¹

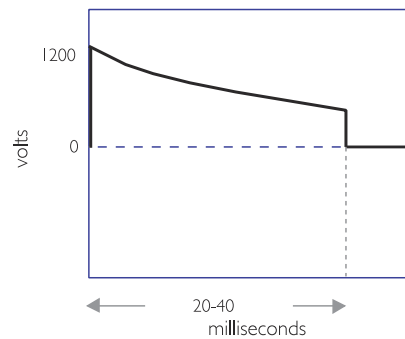

monophasic truncated exponential (MTE) waveform

Despite the phenomenal advances in the medical and electronics fields during the last half of the 20th century, the waveform technology used for external defibrillation remained the same until just recently. In 1992, research scientists and engineers at Heartstream (now part of Philips Medical Systems) began work on what was to become a significant advancement in external defibrillation waveform technology. Extensive studies for implantable defibrillators had shown biphasic waveforms to be superior to monophasic waveforms.^{2,3,4} In fact, a biphasic waveform has been the standard waveform for implantable defibrillators for over a decade. Studies have demonstrated that biphasic waveforms defibrillate at lower energies and thus require smaller components that result in smaller and lighter devices.

Heartstream pursued the use of the biphasic waveform in AEDs for similar reasons; use of the biphasic waveform allows for smaller and lighter AEDs. The SMART Biphasic waveform has been proven effective at an energy level of 150 joules and has been used in HeartStart AEDs since they were introduced in 1996.

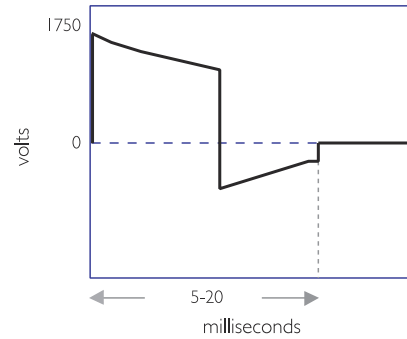

biphasic truncated exponential (BTE) waveform

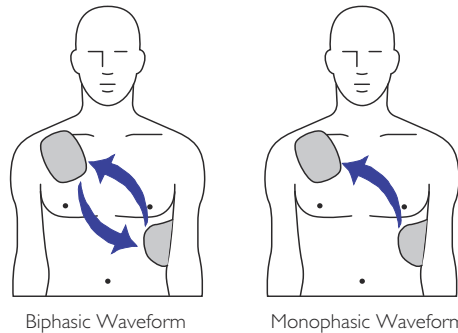

defibrillation current flow

The basic difference between monophasic and biphasic waveforms is the direction of current flow between the defibrillation pads. With a monophasic waveform, the current flows in only one direction. With a biphasic waveform, the current flows in one direction and then reverses and flows in the opposite direction. Looking at the

waveforms, a monophasic waveform has one positive pulse, whereas a biphasic starts with a positive pulse that is followed by a negative one.

In the process of developing the biphasic truncated exponential waveform for use in AEDs, valuable lessons have been learned:

1. Not all waveforms are equally effective. How the energy is delivered (the waveform used) is actually more important than how much energy is delivered.
2. Compensation is needed in the waveform to adjust for differing patient impedances because the effectiveness of the waveform may be affected by patient impedance. The patient impedance can vary due to the energy delivered, electrode size, quality of contact between the electrodes and the skin, number and time interval between previous shocks, phase of ventilation, and the size of the chest.
3. Lower energy is better for the patient because it reduces post-shock dysfunction. While this is not a new idea, it has become increasingly clear as more studies have been published.

The characteristics for the monophasic damped sine and monophasic truncated exponential waveforms are specified in the AAMI standard DF80:2003; the result is that these waveforms are very similar from one manufacturer to the next.

There is no standard for biphasic waveforms, each manufacturer has designed their own. This has resulted in various wave-shapes depending on the design approach used. While it is generally agreed that biphasic waveforms are better than the traditional monophasic waveforms, it is also true that different levels of energy are required by different biphasic waveforms in order to be effective.

SMART BIPHASIC

SMART Biphasic is the patented waveform used by all HeartStart AEDs. It is an impedance-compensating, low energy (<200 J), low capacitance (100 μ F), biphasic truncated exponential (BTE) waveform that delivers a fixed energy of 150 J for defibrillation. Heartstream was the first company to develop a biphasic waveform for use in AEDs.

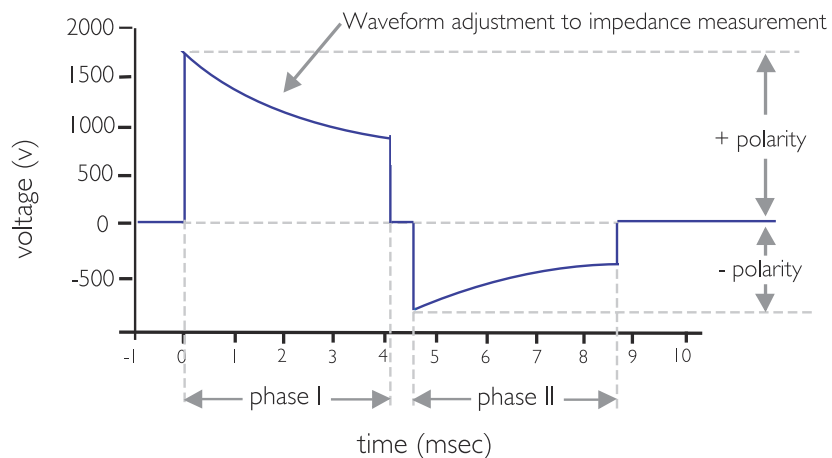

SMART Biphasic waveform

The SMART Biphasic waveform developed by Heartstream compensates for different impedances by measuring the patient impedance during the discharge and using that value to adjust the duration of the waveform to deliver the desired 150 joules. Since the starting voltage is sufficiently large, the delivered energy of 150 joules can be accomplished without the duration ever exceeding 20 milliseconds. The distribution of the energy between the positive and negative pulses was fine tuned in animal studies to optimize defibrillation efficacy and validated in studies conducted in and out of the hospital environment.

Different waveforms have different dosage requirements, similar to a dosage associated with a medication. “If energy and current are too low, the shock will not terminate the arrhythmia; if energy and current are too high, myocardial damage may result.” (1-63)⁵ The impedance compensation used in the SMART Biphasic waveform results in an effective waveform for all patients. The SMART Biphasic waveform has been demonstrated to be just as effective or superior for defibrillating VF when compared to other waveforms and escalating higher energy protocols.

UNDERSTANDING FIXED ENERGY

The BTE waveform has an advantage over the monophasic waveforms related to the shape of the defibrillation response curve. The following graph, based on Snyder et al., demonstrates the difference between the defibrillation response curves for the BTE and the MDS waveform.

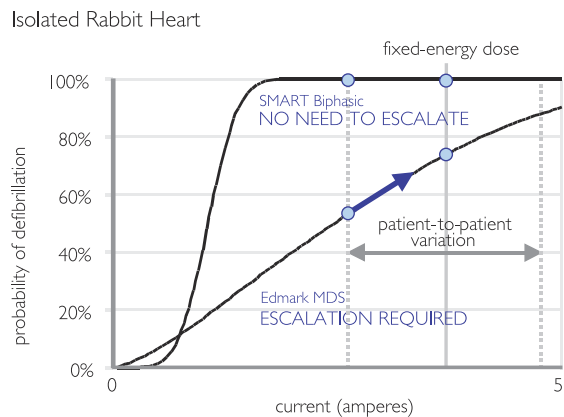

With the gradual slope of the MDS waveform, it is apparent that as current increases, the defibrillation efficacy also increases. This characteristic of the MDS response curve explains why escalating energy is needed with the MDS waveform; the probability of defibrillation increases with an increase in peak current, which is directly related to increasing the energy.

For a given amount of energy the resulting current level can vary greatly depending on the impedance of the patient. A higher-impedance patient receives less current, so escalating the energy is required to increase the probability of defibrillation.

The steeper slope of the BTE waveform, however, results in a response curve where the efficacy changes very little with an increase in current, past a certain current level. This means that if the energy (current) level is chosen appropriately, escalating energy is not required to increase the efficacy. This

fact, combined with the lower energy requirements of BTE waveforms,^{16,18} means that it is possible to choose one fixed energy that allows any patient to be effectively and safely defibrillated.

EVIDENCE-BASED SUPPORT FOR THE SMART BIPHASIC WAVEFORM

Using a process outlined by the American Heart Association (AHA) in 1997,⁶ the Heartstream team put the SMART Biphasic waveform through a rigorous sequence of validation studies. First, animal studies were used to test and fine-tune the waveform parameters to achieve optimal efficacy. Electro-physiology laboratory studies were then used to validate the waveform on humans in a controlled hospital setting. Finally, after receiving FDA clearance for the Heartstream AED, post-market studies were used to prove the efficacy of the SMART Biphasic waveform in the out-of-hospital, emergency-resuscitation environment.

Even when comparing different energies delivered with a single monophasic waveform, it has been demonstrated that lower-energy shocks result in fewer post shock arrhythmias.⁷ Other studies have demonstrated that the biphasic waveform has several clinical advantages. It has equivalent efficacy to higher energy monophasic waveforms but shows no significant ST segment change from the baseline.⁸ There is also evidence of less post shock dysfunction when the biphasic waveform is used.^{9,10,11,29} There is evidence that the biphasic waveform has improved performance when anti-arrhythmic drugs are present,^{12,13} and with long duration VF.^{14,20} A more recent study has also demonstrated improved neurological outcomes for survivors defibrillated with SMART Biphasic when compared to patients defibrillated with monophasic waveforms.¹⁵

The bottom line is that the SMART Biphasic waveform has been demonstrated to be just as effective or superior to monophasic waveforms at defibrillating patients in VF. In addition, there are indications that patients defibrillated with the SMART Biphasic waveform suffer less dysfunction than those defibrillated with conventional escalating-energy monophasic waveforms. SMART Biphasic has been used in AEDs for over a decade, and there are numerous studies to support the benefits of this waveform, including out-of-hospital data with long-down-time VF.

SMART BIPHASIC SUPERIOR TO MONOPHASIC

Researchers have produced over 20 peer-reviewed manuscripts to prove the efficacy and safety of the SMART Biphasic waveform. Thirteen of these are out-of-hospital studies that demonstrated high efficacy of the SMART Biphasic waveform on long-down-time patients in emergency environments. No other waveform is supported by this level of research.

Using criteria established by the AHA in its 1997 Scientific Statement,²⁷ the data from the ORCA study^{15,34} demonstrate that the 150J SMART Biphasic waveform is superior to the 200J - 360J escalating energy monophasic waveform in the treatment of out-of-hospital cardiac arrest. This is true for one-shock, two-shock, and three-shock efficacy and return of spontaneous circulation.

KEY STUDIES

PHILIPS MEDICAL SYSTEMS

year	waveforms studied	results
1992	low-energy vs. high-energy damped sine monophasic	249 patients (emergency resuscitation). Low-energy and high-energy damped sine monophasic are equally effective. Higher energy is associated with increased incidence of A-V block with repeated shocks. ⁷
1994	biphasic vs. damped sine monophasic	19 swine. Biphasic shocks defibrillate at lower energies, and with less post-shock arrhythmia, than monophasic shocks. ¹⁶
1995		171 patients (electrophysiology laboratory). First-shock efficacy of biphasic damped sine is superior to high-energy monophasic damped sine. ¹⁷
1995	low-energy truncated biphasic vs. high-energy damped sine monophasic	30 patients (electrophysiology laboratory). Low-energy truncated biphasic and high-energy damped sine monophasic equally effectiveness. ¹⁸
1996	115 J and 130 J truncated biphasic vs. 200 J and 360 J damped sine monophasic	294 patients (electrophysiology laboratory). Low-energy truncated biphasic and high-energy damped sine monophasic are equally effective. High-energy monophasic is associated with significantly more post-shock ST-segment changes on ECG. ⁸ This study of a 115 J and 130 J waveform contributed to the development of the 150 J, nominal, therapy that ships with Philips AEDs.
1997	SMART Biphasic vs. standard high-energy monophasic	18 patients (10 VF, emergency resuscitation). SMART Biphasic terminated VF at higher rates than reported damped sine or truncated exponential monophasic. ¹⁹
1998		30 patients (electrophysiology laboratory). High-energy monophasic showed significantly greater post-shock ECG ST-segment changes than SMART Biphasic. ⁹
1999		286 patients (100 VF, emergency resuscitation). First-shock efficacy of SMART Biphasic was 86% (compared to pooled reported 63% for damped sine monophasic); three or fewer shocks, 97%; 65% of patients had organized rhythm at hand-off to ALS or emergency personnel. ²⁰
		116 patients (emergency resuscitation). At all post-shock assessment times (3 - 60 seconds) SMART Biphasic patients had lower rates of VF. Refibrillation rates were independent of waveform. ¹⁰
1999	low-energy (150 J) vs. high-energy (200 J) biphasic	20 swine. Low-energy biphasic shocks increased likelihood of successful defibrillation and minimized post-shock myocardial dysfunction after prolonged arrest. ²¹

year	waveforms studied	results
1999	low-capacitance biphasic vs. high-capacitance biphasic	10 swine. Five of five low-capacitance shock animals were resuscitated, compared to two of five high-capacitance at 200 J. More cumulative energy and longer CPR were required for high-capacitance shock animals that survived. ²²
1999		10 swine. Stroke volume and ejection fraction progressively and significantly reduced at 2, 3, and 4 hours post-shock for monophasic animals but improved for biphasic animals. ¹¹
2000	SMART Biphasic vs. escalating high-energy monophasic	338 patients (115 VF, emergency resuscitation). Demonstrated superior defibrillation performance in comparison with escalating, high-energy monophasic shocks in out-of hospital cardiac arrest (average time from call to first shock was 8.9 minutes). SMART Biphasic defibrillated at higher rates than MTE and MDS (96% first-shock efficacy vs. 59%), with more patients achieving ROSC. Survivors of SMART Biphasic resuscitation were more likely to have good cerebral performance at discharge, and none had coma (vs. 21% for monophasic survivors). ¹⁵
2001		338 patients (115 VF, emergency resuscitation). Use of a low-energy impedance-compensating biphasic waveform device resulted in superior first-shock efficacy, in the first set of two or three shocks, time to shock, and first successful shock compared to traditional defibrillators using escalating energy monophasic truncated exponential and monophasic damped sine waveforms. ³⁴
2004		62 patients (shockable rhythms; 41% of patients were classified as overweight, 24% as obese, and 4% as extremely obese). Overweight patients were successfully defibrillated by the 150 J SMART Biphasic waveform, without energy escalation. ³⁵
2005	SMART Biphasic	102 patients (all presenting with shockable rhythms). SMART Biphasic successfully defibrillated high-impedance patients without energy escalation. Rapid defibrillation rather than differences in patient impedance accounted for resuscitation success. ³⁶

FREQUENTLY ASKED QUESTIONS

ARE ALL BIPHASIC WAVEFORMS ALIKE?

No. Different waveforms perform differently, depending on their shape, duration, capacitance, voltage, current, and response to impedance. Different biphasic waveforms are designed to work at different energies. As a result, an appropriate energy dose for one biphasic waveform may be inappropriate for a different waveform.

There is evidence to suggest that a biphasic waveform designed for low-energy defibrillation may result in overdose if applied at high energies (the Tang AHA abstract from 1999 showed good resuscitation performance for the SMART Biphasic waveform, but more shocks were required at 200 J than at 150 J²¹). Conversely, a biphasic waveform designed for high-energy defibrillation may not defibrillate effectively at lower energies. (The Tang AHA abstract from 1999 showed poor resuscitation performance for the

200 µF capacitance biphasic waveform at 200 J compared to the 100 µF capacitance biphasic waveform [SMART Biphasic] at 200 J.²² The Higgins manuscript from 2000 showed that the 200 µF capacitance biphasic waveform performed better at 200 J than at 130 J.²³)

It is consequently necessary to refer to the manufacturer's recommendations and the clinical literature to determine the proper dosing for a given biphasic waveform. The recommendations for one biphasic waveform should not be arbitrarily applied to a different biphasic waveform. "It is likely that the optimal energy level for biphasic defibrillators will vary with the units' waveform characteristics. An appropriate energy dose for one biphasic waveform may be inappropriate for another."²⁴

SMART Biphasic was designed for low-energy defibrillation, while some other biphasic waveforms were not. It would be irresponsible to use a waveform designed for high energy with a low-energy protocol.

HOW CAN THE SMART BIPHASIC WAVEFORM BE MORE EFFECTIVE AT LOWER ENERGY?

The way the energy is delivered makes a significant difference in the efficacy of the waveform. Electric current has been demonstrated to be the variable most highly correlated with defibrillation efficacy. The SMART Biphasic waveform uses a 100 µF capacitor to store the energy inside the AED; other biphasic waveforms use a 200 µF capacitor to store the energy. The energy (E) stored on the capacitor is given by the equation:

$$E = \frac{1}{2} C V^2$$

The voltage (V) and the current (I) involved with defibrillating a patient are related to the patient impedance (R) by the equation:

$$V = I R$$

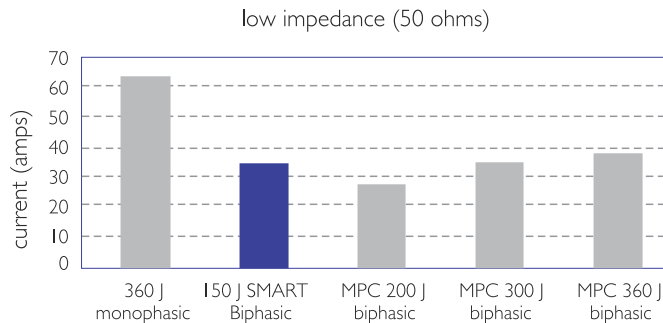

Peak Current Levels

For the 200 μF capacitance biphasic waveform to attain similar levels of current to the SMART Biphasic (100 μF) waveform, it must apply the same voltage across the patient's chest. This means that to attain similar current levels, the 200 μF biphasic waveform must store twice as much energy on the capacitor and deliver much more energy to the patient; the graph at right demonstrates this relationship. This is the main reason why some biphasic waveforms require higher energy doses than the SMART Biphasic waveform to attain similar efficacy.

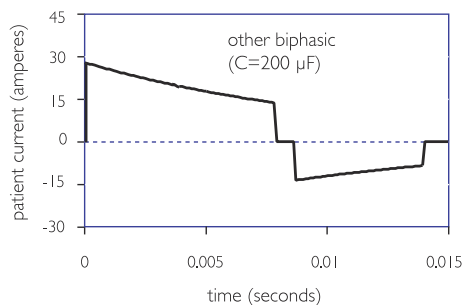
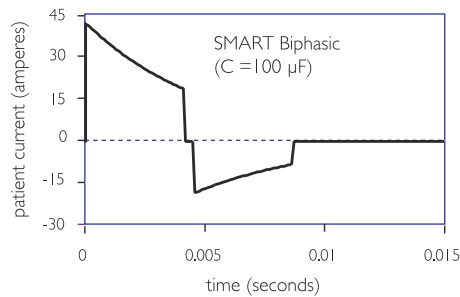

The illustrations to the left show the SMART Biphasic waveform and another biphasic waveform with a higher capacitance, similar to that used by another AED manufacturer. The low capacitance used by the patented SMART Biphasic waveform delivers energy more efficiently. In an animal study using these two waveforms, the SMART Biphasic waveform successfully resuscitated all animals and required less cumulative energy and shorter CPR time than the other biphasic waveform, which resuscitated only 40% of the animals.²²

The amount of energy needed depends on the waveform that is used. SMART Biphasic has been demonstrated to effectively defibrillate at 150 J in out-of-hospital studies.¹⁵ Animal studies have indicated that the SMART Biphasic waveform would not be more effective at higher energies²¹ and this seems to be supported with observed out-of-hospital defibrillation efficacy of 96% at 150 J.¹⁵

IS ESCALATING ENERGY REQUIRED?

Not with SMART Biphasic technology. In the “Guidelines 2010,”³⁵ the AHA states, “Energy levels vary by type of device” (page S708). The SMART Biphasic waveform has been optimized for ventricular defibrillation efficacy at 150 J. The Guidelines state, “Data from both out-of-hospital and in-hospital studies indicate that lower-energy biphasic waveform shocks have equivalent or higher success for termination of VF than either MDS or MTE monophasic waveform shocks” (page S708).

The Guidelines also state that “the optimal energy for first-shock biphasic waveform defibrillation has not been determined,” noting that “multiple

prospective human clinical studies and retrospective studies have failed to identify an optimal biphasic energy level for first or subsequent shocks. ... Different biphasic waveforms have not been compared in humans with regard to efficacy. Therefore, for biphasic defibrillators, providers should use the manufacturer's recommended energy dose (120 to 200 J) (Class I, LOE B)" (page S703).

Some have suggested that a patient may need more than 150 J with a BTE waveform when conditions like heart attacks, high-impedance, delays before the first shock, and inaccurate electrode pad placement are present. This is not true for the SMART Biphasic waveform, as the evidence presented in the following sections clearly indicates. On the other hand, the evidence indicates that other BTE waveforms may require more than 150 J for defibrillating patients in VF.

Heart Attacks

One manufacturer references only animal studies using their waveform to support their claim that a patient may require more than 200 J for cardiac arrests caused by heart attacks (myocardial infarction) when using their waveform. The SMART Biphasic waveform has been tested in the real world with real heart attack victims and has proven its effectiveness at terminating ventricular fibrillation (VF). In a prospective, randomized, out-of-hospital study, the SMART Biphasic waveform demonstrated a first shock efficacy of 96% versus 59% for monophasic waveforms, and 98% efficacy with 3 shocks as opposed to 69% for monophasic waveforms.¹⁵ Fifty-one percent of the victims treated with the SMART Biphasic waveform were diagnosed with acute myocardial infarction. The published evidence clearly indicates that the SMART Biphasic waveform does not require more than 150 J for heart attack victims.

High-Impedance or Large Patients

High impedance patients do not pose a problem with the low energy SMART Biphasic waveform. Using a patented method, SMART Biphasic technology automatically measures the patient's impedance and adjusts the waveform dynamically during each shock to optimize the waveform for each shock on each patient. As demonstrated in published, peer-reviewed clinical literature, the SMART Biphasic waveform is as effective at defibrillating patients with high impedance (greater than 100 ohms) as it is with low-impedance patients.¹⁹ The bottom line is that the SMART Biphasic waveform does not require more than 150 J for high-impedance patients.

Data collected from a group of patients defibrillated by the Rochester, Minnesota, EMS organization during actual resuscitation attempts was examined to determine if patient weight affected the defibrillation effectiveness of the 150 J non-escalating SMART biphasic shock that was used. Of the patients for whom both weight and height data were available,

41% were overweight, 24% were obese, and 4% were extremely obese by BMI (Body Mass Index) standards. As shown in the graph below, the success and failure distributions were identical for the three groups. Thus, defibrillation effectiveness on the first shock was in no way related to the weight of the patient. The cumulative two-shock success rate was 99%, and all patients were defibrillated by the third shock.

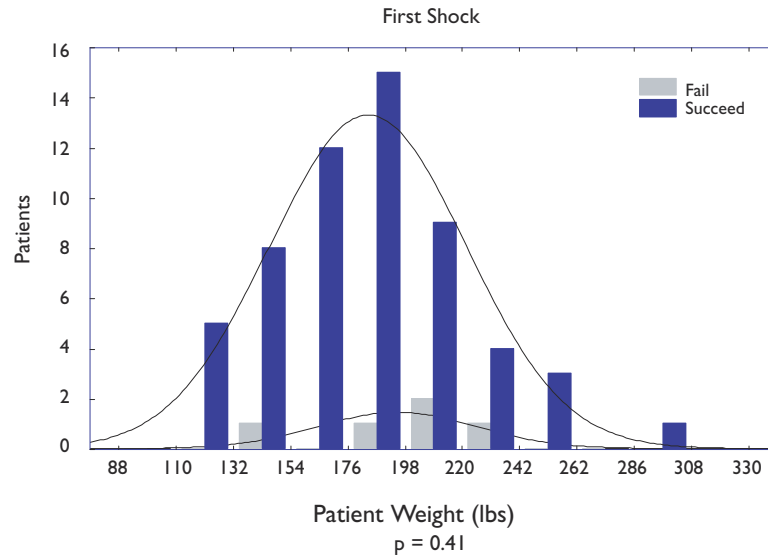

Delays before the First Shock

The SMART Biphasic waveform is the only biphasic waveform to have extensive, peer-reviewed and published emergency resuscitation data for long-duration VF. In a randomized out-of-hospital study comparing the low-energy SMART Biphasic waveform to high-energy escalating monophasic waveforms, the average collapse-to-first-shock time was 12.3 minutes. Of the 54 patients treated with the SMART Biphasic waveform, 100% were successfully defibrillated, 96% on the first shock and 98% with three or fewer shocks. With the monophasic waveforms, only 59% were defibrillated on the first shock and only 69% with three or fewer shocks. Seventy-six percent of the patients defibrillated with the SMART Biphasic waveform experienced a return of spontaneous circulation (ROSC), versus only 55% of the patients treated with high-energy monophasic waveforms.¹⁵ In a post-market, out-of-hospital study of 100 VF patients defibrillated with the SMART Biphasic waveform, the authors concluded, “Higher energy is not clinically warranted with this waveform.”²⁰ SMART Biphasic does not require more than 150 J when there are delays before the first shock.

Inaccurate Electrode Pad Placement

The claim that more energy is possibly required if the pads are not placed properly is a purely speculative argument with no basis in scientific evidence. However, common sense would suggest that if a given biphasic waveform needs more energy when pads are located properly, why would it perform any better if the pads were placed sub-optimally? Once again, the real world data demonstrates high efficacy with the SMART Biphasic waveform in out-of-hospital studies.^{15,20} These studies included hundreds of AED users with a variety of different backgrounds.

IS THERE A RELATIONSHIP BETWEEN WAVEFORM, ENERGY LEVEL, AND POST-SHOCK DYSFUNCTION?

Yes. Higher-energy defibrillation waveforms - whether monophasic or biphasic - are associated with increased post-shock cardiac dysfunction.

There is a difference between damage and dysfunction. In the context of post-shock cardiac assessment, “damage” can be defined as irreversible cell death, as measured by various enzyme tests. “Dysfunction” is reflected in reduced cardiac output as a result of reversible myocardial stunning. Dysfunction can result in significantly reduced cardiac output for many hours post-resuscitation. Waveforms that do not cause damage can cause dysfunction.

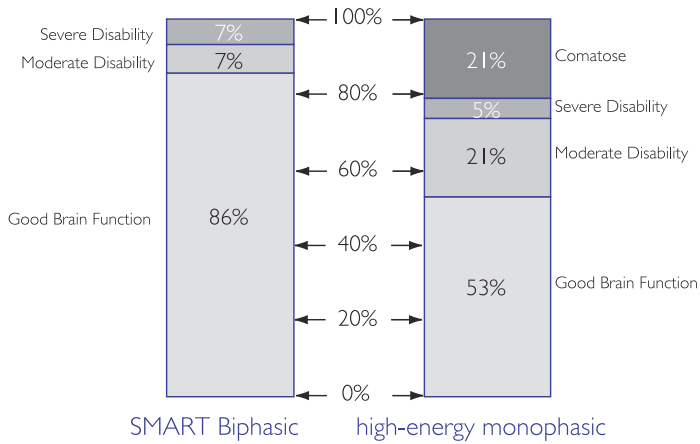
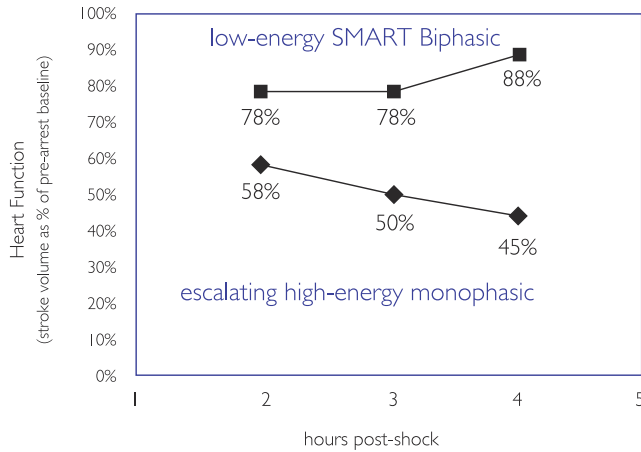

PHILIPS MEDICAL SYSTEMS

Evidence of this dysfunction includes electrocardiogram (ECG) abnormalities.^{8,28} A study of escalating-energy monophasic waveforms found that increased levels of delivered energy were associated with increased evidence of impaired myocardial contractility and perfusion failure. The authors conclude: “The severity of post-resuscitation myocardial dysfunction is related, at least in part, to the magnitude of electrical energy of the delivered shock.”²⁹ Several other studies also provide data to support this conclusion for biphasic as well as monophasic waveforms.^{21,30,31}

Post-resuscitation brain dysfunction is another important area that warrants further study. In a randomized study of 115 out-of-hospital SCA patients with VF, 54 were shocked with the SMART Biphasic waveform and the remainder with escalating high-energy monophasic devices. In this study, 87% of SMART Biphasic survivors had good brain function when discharged from the hospital, as opposed to only 53% of monophasic escalating-energy survivors. None of the SMART Biphasic patients experienced post-shock coma, while 21% of monophasic survivors did.¹⁵

HOW DOES SMART BIPHASIC COMPARE TO OTHER BIPHASIC WAVEFORMS?

While there is a large body of literature published about the SMART Biphasic waveform, there is very little published research about other biphasic defibrillation waveforms.

Comparing waveform results within a single, controlled study can yield meaningful information. However, comparing the results from separate studies can be extremely misleading, due to any number of uncontrolled differences from study to study. The same waveform can perform differently in different studies, depending on how each study is set up.

The results of an animal study comparing the SMART Biphasic waveform to a type of biphasic waveform used by another manufacturer establish that the SMART Biphasic waveform increases the likelihood of successful defibrillation, minimizes post-shock myocardial dysfunction, and requires less cumulative energy.²²

IS THERE A STANDARD FOR BIPHASIC ENERGY LEVELS?

No. The data supporting low-energy biphasic defibrillation has been reviewed by the American Heart Association (AHA), which found the therapy to be “safe, effective, and clinically acceptable.” As stated by the AHA, “A review of previous AHA guidelines for the [monophasic] energy sequence 200 J- 300 J-360 J reveals that the evidence supporting this reputed 'gold standard' is largely speculative and is based largely on common sense extrapolation... Multiple high energy shocks could easily result in more harm than good.”³²

Since there are differences between the biphasic waveforms available, the proper energy level for a particular biphasic waveform depends on how it was designed and should be specified by the manufacturer. The proper energy level for SMART Biphasic is 150 J, as demonstrated by the studies completed. When referencing these studies and the SMART Biphasic waveform, the AHA states that, “The growing body of evidence is now considered sufficient to support a Class IIa recommendation for this low energy, BTE waveform.”⁵ The AHA defines a Class IIa as, “Good/very good evidence,” “Considered standard of care,” and “Considered intervention of choice by a majority of experts.”⁵

In the same guidelines, the AHA also issued a similar recommendation for the general practice of low-energy biphasic defibrillation, but cautioned that, “at this time no studies have reported experience with other biphasic waveforms in long-duration VF in out-of-hospital arrest. When such data becomes available, it will need to be assessed by the same evidence evaluation process as used for the biphasic defibrillator and this guidelines process.”

COMMITMENT TO SMART BIPHASIC

All HeartStart defibrillator products use the 150 J SMART Biphasic waveform. The HeartStart XL and MRx are manual defibrillators designed to be used by advanced cardiac life support personnel, but they also include an AED mode. These products provide selectable energy settings from 2 to 200 J in the manual mode but utilize a constant 150 J in the AED mode.

Some waveforms may need more than 150 J for defibrillation, but the SMART Biphasic waveform does not. Published clinical evidence indicates that the SMART Biphasic waveform does not require more than 150 J to effectively defibrillate, even if the patient has experienced a heart attack, has a higher than normal impedance, or if there have been delays before the first shock is delivered. Published clinical evidence also indicates that there is increased dysfunction associated with high-energy shocks.^{7,8,29,30,33}

Since the SMART Biphasic waveform has been proven effective for defibrillation at 150 J, there is no need to deliver more energy.

REFERENCES

1. Jones JL and Jones RE. Postshock arrhythmias - a possible cause of unsuccessful defibrillation. *Critical Care Medicine* 1980;8(3):167-71.
2. Winkle RA, et al. Improved low energy defibrillation energy in man with the use of a biphasic truncated exponential waveform. *American Heart Journal* 1989;117:122-127.
3. Bardy GH et al. A prospective, randomized evaluation of biphasic vs monophasic waveform pulses on defibrillation efficacy in humans. *Journal of the American College of Cardiology* 1989;14:728-733.
4. Schwartz JF, et al. Optimization of biphasic waveforms for human nonthoracotomy defibrillation. *Circulation* 1993;33:2646-2654.
5. American Heart Association. *Guidelines 2005 for Cardiopulmonary Resuscitation and Emergency Cardiovascular Care* December 2005.
6. American Heart Association Task Force on Automatic External Defibrillation, Subcommittee on AED Safety and Efficacy. AHA Scientific Statement. Automatic external defibrillators for public access defibrillation: Recommendations for specifying and reporting arrhythmia analysis algorithm performance, incorporating new waveforms, and enhancing safety. *Circulation* 1997;95:1277-1281.
7. Weaver WD, et al. Ventricular defibrillation-A comparative trial using 175J and 320J shocks. *New England Journal of Medicine* 1982;307:1101-1106.
8. Bardy GH, et al. Multicenter comparison of truncated biphasic shocks and standard damped sine wave monophasic shocks for transthoracic ventricular defibrillation. *Circulation* 1996;94:2507-2514.
9. Reddy RK, et al. Biphasic transthoracic defibrillation causes fewer ECG ST-segment changes after shock. *Annals of Emergency Medicine* 1997;30:127-134.
10. Gliner BE and White RD. Electrocardiographic evaluation of defibrillation shocks delivered to out-of-hospital sudden cardiac arrest patients. *Resuscitation* 1999;41:133-144.
11. Tang W, Weil MH, Sun Shijie, et al. Defibrillation with low-energy biphasic waveform reduces the severity of post-resuscitation myocardial dysfunction after prolonged cardiac arrest. *Journal of Critical Care Medicine* 1999;27:A43.
12. Ujhelyi, et al. *Circulation* 1995;92(6):1644-1650
13. Kopp, et al. *PACE* 1995;18:872
14. Poole JE, et al. Low-energy impedance-compensating biphasic waveforms terminate ventricular fibrillation at high rates in victims of out-of-hospital cardiac arrest. *Journal of Electrophysiology* 1997;8:1373-1385.
15. Schneider T, Martens PR, Paschen H, et al. Multicenter, randomized, controlled trial of 150-joule biphasic shocks compared with 200- to 360-joule monophasic shocks in the resuscitation of out-of-hospital cardiac arrest victims. *Circulation* 2000;102:1780-1787.
16. Gliner BE, et al. Transthoracic defibrillation of swine with monophasic and biphasic waveforms. *Circulation* 1995;92:1634-1643.
17. Greene HL, DiMarco JP, Kudenchuk PJ, et al. Comparison of monophasic and biphasic defibrillating pulse waveforms for transthoracic cardioversion. *American Journal of Cardiology* 1995;75:1135-1139.
18. Bardy GH, Gliner BE, Kudenchuk PJ, et al. Truncated biphasic pulses for transthoracic defibrillation. *Circulation* 1995;64:2507-2514.
19. White RD. Early out-of-hospital experience with an impedance-compensating low-energy biphasic waveform automatic external defibrillator. *Journal of Interventional Cardiac Electrophysiology* 1997;1:203-208.
20. Gliner BE, et al. Treatment of out-of-hospital cardiac arrest with a low-energy impedance-compensating biphasic waveform automatic external defibrillator. *Biomedical Instrumentation & Technology* 1998;32:631-644.
21. Tang W, et al. Effects of low- and higher-energy biphasic waveform defibrillation on success of resuscitation and post-resuscitation myocardial dysfunction after prolonged cardiac arrest. *Circulation (supplement)* 1999;100(18):I-662 (abstract).
22. Tang W, et al. Low capacitance biphasic waveform shocks improve immediate resuscitation after prolonged cardiac arrest. *Circulation (supplement)* 1999;100(18):I-663 (abstract).
23. Higgins SL, et al. A Comparison of Biphasic and Monophasic Shocks for External Defibrillation. *PreHospital Emergency Care* 2000; 4:305-313.

24. ECRI. External Biphasic Defibrillators, Should You Catch the Wave? *Health Devices*. June 2001, Volume 30, Number 6.
25. Kerber RE, et al. Automatic external defibrillators for public access defibrillation: recommendations for specifying and reporting arrhythmia analysis algorithm performance, incorporating new waveforms, and enhancing safety. *Circulation* 1997; 95:1677-1682.
26. Reddy RK, et al. Biphasic transthoracic defibrillation causes fewer ECG ST-segment changes after shock. *Annals of Emergency Medicine* 1997;30:127-134.
27. Xie J, et al. High-energy defibrillation increases the severity of postresuscitation myocardial function. *Circulation* 1997;96:683-688.
28. Tokano T, et al. Effect of ventricular shock strength on cardiac hemodynamics. *Journal of Cardiovascular Electrophysiology* 1998;9:791-797.
29. Cates AW, et al. The probability of defibrillation success and the incidence of postshock arrhythmia as a function of shock strength. *PACE* 1994;17:1208-1217.
30. Cummins RO, et al. Low-energy biphasic waveform defibrillation: Evidence-based review applied to emergency cardiovascular care guidelines: A statement for healthcare professionals from the American Heart Association Committee on Emergency Cardiovascular Care and the Subcommittees on Basic Life Support, Advanced Cardiac Life Support, and Pediatric Resuscitation. *Circulation* 1998;97:1
31. Tang W, et al. Defibrillation with low-energy biphasic waveform reduces the severity of post-resuscitation myocardial dysfunction after prolonged cardiac arrest. *Journal of Critical Care Medicine*. (Abstract) 1999;27:A43.
32. Martens PR, Russell JK, Wolcke B, Paschen H, Kuisma D, Schneider T. Optimal response to cardiac arrest study: defibrillation waveform effects. *Resuscitation* 2001; 49:233-243.
33. White RD, Blackwell TH, Russell JK, Jorgenson DB. Body weight does not affect defibrillation, resuscitation or survival in patients with out-of-hospital biphasic waveform defibrillator. *Critical Care Medicine* 2004; 32(9) Supplement: S387-S392.
34. White RD, Blackwell TH, Russell JK, Snyder DE, Jorgenson DB. Transthoracic impedance does not affect defibrillation, resuscitation or survival in patients with out-of-hospital cardiac arrest treated with a non-escalating biphasic waveform defibrillator. *Resuscitation* 2005 Jan; 64(1):63-69.
35. American Heart Association. 2010 Guidelines for Cardiopulmonary Resuscitation and Emergency Cardiovascular Care Science. *Circulation* 2010;122[suppl 3].

4 SMART ANALYSIS

SMART Analysis refers to the proprietary analysis system used in HeartStart AEDs that analyzes a patient's ECG and determines whether a shock should be delivered. It consists of three parts: pad contact quality, artifact detection, and arrhythmia detection. These three parts work together to enable the defibrillator to read an ECG and evaluate the available information to determine if a shock is appropriate.

PAD CONTACT QUALITY

This part of the analysis system continuously monitors the patient impedance to ensure that it remains within the appropriate range. This impedance measurement is a low signal measurement made through the front-end circuitry of the defibrillator and is different from the impedance measurement made at the beginning of the SMART Biphasic waveform.

If the measured impedance is too high, it may indicate that the pads are not properly applied or that there may be a problem with the pad/skin interface. Unless this is corrected, the defibrillator will not be able to read the ECG effectively to determine whether a shock is advised. Poor pad connection can also cause a problem with the delivery of current to the patient. If the patient impedance is above the appropriate range, the HeartStart AED will issue voice prompts directing the user's attention to the pads, announcing that pads contact is poor and instructing the user to apply pads or to press the pads firmly to correct the situation.

ARTIFACT DETECTION

OVERVIEW

Whenever any electrical signal (such as an ECG) is measured, there is invariably a certain amount of electrical noise in the environment that can interfere with an accurate measurement. Artifact detection is important in an ECG analysis system because it allows detection of this extraneous electrical noise so that it can either be filtered out or compensated for. Motion detection is one way of dealing with this noise, but it is only important if the motion produces artifact on the ECG signal. Any artifact that is undetected can lead to incorrect decisions by the algorithm and can cause incorrect or delayed treatment of the patient.

Artifact can be caused in a variety of ways, including CPR, agonal breathing, transportation, patient handling, and the presence of a pacemaker in the patient. The action taken depends on how the artifact looks in relation to the ECG signal.

Artifact detection in HeartStart AEDs is accomplished by measuring the amount of static electricity sensed by the pads; this static is considered to be artifact signal. This artifact signal is then compared to the ECG signal. If they correlate, then artifact is detected and appropriate voice prompts are given so the user can take appropriate action. However, if it does not correlate with the ECG, then analysis proceeds and the defibrillator makes shock/no-shock decisions.

If the amplitude of the underlying ECG signal is small compared to an artifact signal, then the HeartStart AED will respond by giving voice prompts that tell the user not to touch the patient, that analyzing has been interrupted, or to stop all motion. In this situation, the defibrillator can not accurately analyze the underlying ECG because the amount of electrical noise present has corrupted the ECG signal. The AED messages given in this situation are designed to prompt the user to take actions that will stop or minimize the artifact in the environment.

If the amplitude of the ECG signal is sufficiently high compared to the artifact signal or if the artifact does not correlate with the ECG signal, the artifact will not interfere with the normal operation of the AED. In these cases, the defibrillator recognizes that artifact is present, but the defibrillator can continue to make shock decisions and deliver a shock if appropriate.

CPR at High Rates of Compression

CPR rates significantly above 100 compressions per minute can cause incorrect or delayed analysis by the HeartStart AED. CPR performed with chest compressions of rates over 135/minute can sometimes mimic a shockable rhythm. In the presence of detected high CPR rates, the AED will interrupt the rescuer doing CPR and give an instruction to not touch the patient. It is important to emphasize that CPR should be done at a reasonable rate in order to avoid unnecessary interruptions of patient treatment.

Pacemaker Detection

In the event that the patient has an implanted pacemaker, HeartStart AEDs have special filters that remove the pacemaker artifact and allow the defibrillator to shock the patient if appropriate. Pacemaker artifact is removed from the signal for rhythm analysis. The two strips in the following figure represent the ECG before and after the pacemaker artifact is filtered out.

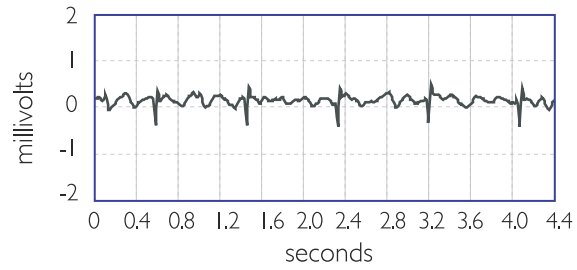

Before filtering: Underlying rhythm VF, pacemaker artifact

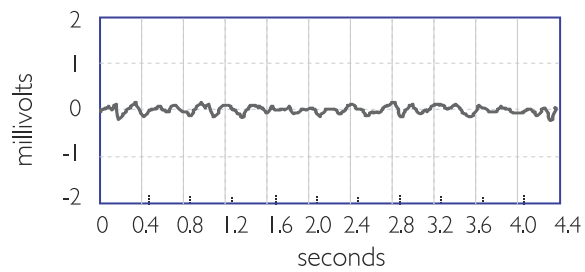

After filtering: Underlying rhythm VF, no pacemaker artifact

Even with a sophisticated artifact detection system, not all artifact can be detected during the use of the AED. This is why it is important to listen to the voice prompts given by the AED and to not touch the patient while it is analyzing the ECG. Below is an example of rapid CPR done in such a way that it was not detected by the analysis system. The second strip shows the underlying asystole present when CPR is stopped. Because HeartStart AEDs continually monitor the ECG and look for changes in the rhythm, the unit quickly disarmed automatically in this situation when CPR was discontinued and no shock was delivered to the patient. Asystole is not considered a shockable rhythm.

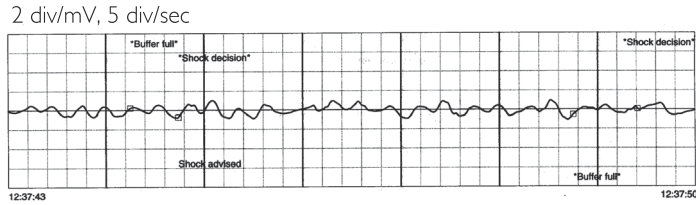

CPR artifact: underlying rhythm asystole

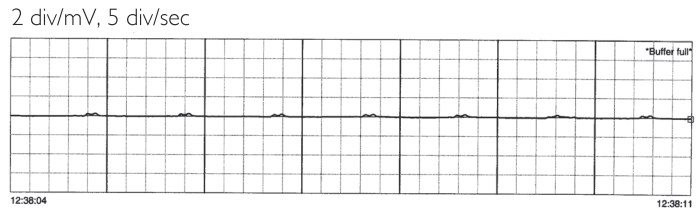

Post-CPR: underlying rhythm asystole

Delivering a shock to a patient in asystole will not return the heart to a normal rhythm and may actually prevent more appropriate therapies from being successful.

ARRHYTHMIA DETECTION

A crucial factor in the safety and performance of an AED is the device's ability to accurately assess the cardiac state of the patient. The AED performs this evaluation by sensing electrical signals from the patient's heart via electrodes and using a computerized algorithm to interpret the electrical signals and make a therapy decision.

The HeartStart analysis system (SMART Analysis) was developed and tested to ensure that its sensitivity (ability to detect shockable rhythms) and the specificity (ability to detect non-shockable rhythms) exceeded the AHA and AAMI DF80 recommendations. The ECG strips contained in the development database represent hundreds of examples of various rhythms obtained from numerous clinical studies.

To determine if a patient's rhythm is shockable, the SMART Analysis system evaluates four parameters of the ECG in 4.0-second segments. The four parameters are the amplitude, rate, conduction (shape of the QRS complex), and stability of the rhythm (repeatability of the waveform pattern). A brief discussion of each of these parameters follows.

Rate

Rate is determined by how many times the heart beats per minute (bpm). A healthy heart beats 60-100 bpm. Some normal rhythms can be very fast. Therefore, it is important to have additional indicators in the analysis system of an AED. Rate is used along with the other parameters to help determine whether the rhythm is shockable. The

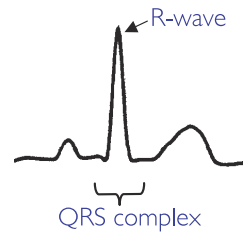

higher the rate, the more likely a rhythm is shockable. The lowest rate to be shocked is 135 bpm, and this applies to those rhythms that are most disorganized, such as VF. The more organized a rhythm is, the higher the rate must be in order to be shockable. However, rhythms with narrow QRS complexes (such as SVT) will not be shocked, regardless of the rate.

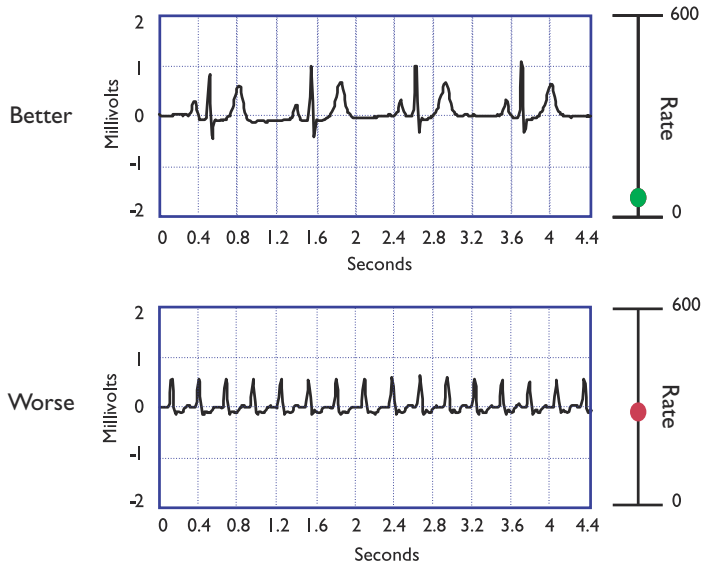

Rate parameter

Conduction

Conduction is determined by examining the R-wave of the QRS complex. conduction is related to the propagation of electrical impulses through the ventricles. In a healthy heart, the ventricles contract in unison, which is reflected in the ECG by narrow QRS complexes with sharp transitions. Non-perfusing rhythms are characterized by wide complexes with smooth transitions. Therefore, a rhythm with wide complexes and smooth transitions is more likely to be shocked.

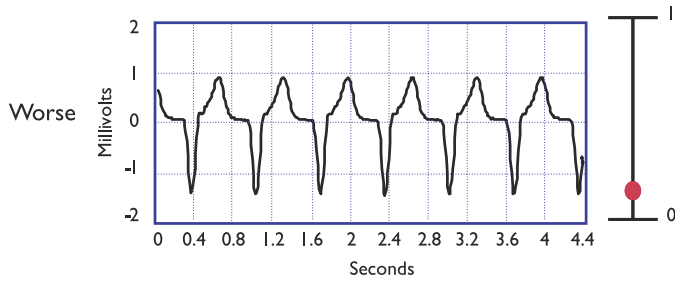
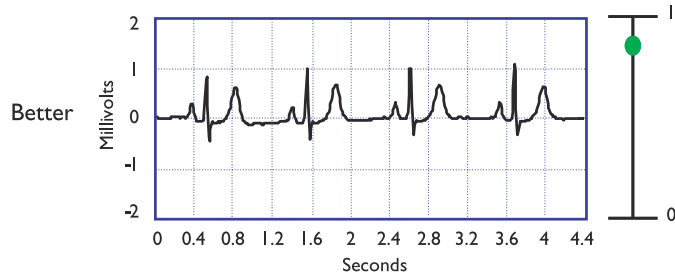

Conduction parameter

STABILITY

Stability refers to the repeatability of the ECG complexes. The consistency of both the shape of the complex and the period between complexes also indicates whether a rhythm is perfusing. With a perfusing rhythm, the sequential complexes tend to be very similar in shape. An unhealthy heart will have chaotic, unstable complexes.

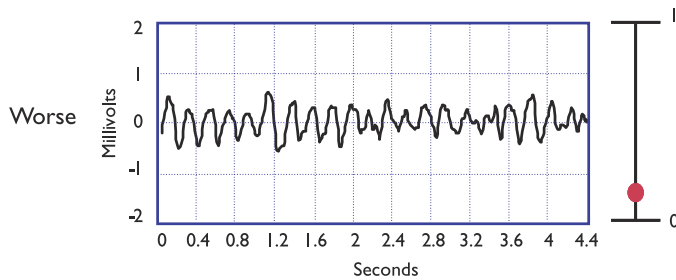
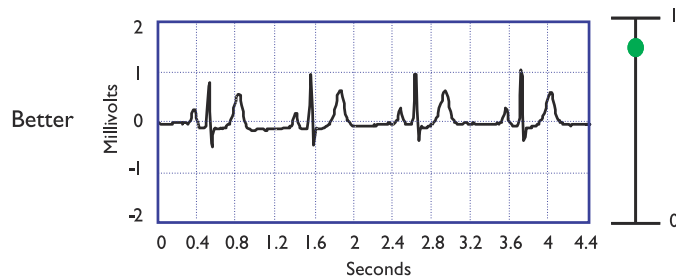

Stability parameter

AMPLITUDE

Amplitude is a measure of magnitude of the heart's electrical activity. A heart that is in asystole, or “flatline,” will have a low-amplitude ECG. Amplitude is very dependent on the patient and pads placement and is therefore the least important of the four indicators.

SMART Analysis simultaneously measures the first three indicators above over 4.5 second segments of ECG, and then classifies each segment of ECG as shockable or non-shockable. Amplitude is used as a gating check to determine if a strip is considered shockable; i.e. the 4.5 second strip of ECG must have at least a 100 μV peak-to-peak median amplitude in order for a strip to be considered VF.

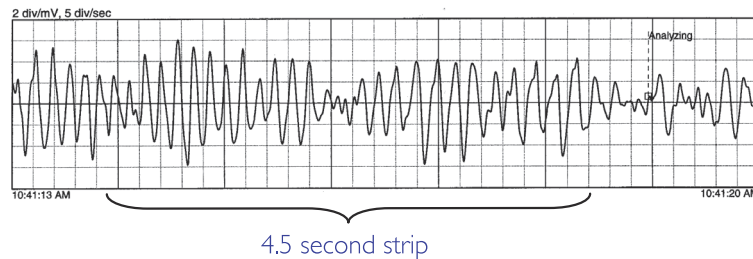

The AED must identify multiple ECG strips as shockable before it will allow the device to arm. The device must then continue to see shockable strips in order to allow a shock to be delivered. HeartStart AEDs differ from other AEDs in that they continue to monitor the ECG even after a shock decision has been made and the unit has charged; this means that the HeartStart AED will react to a change in rhythm and disarm if the rhythm becomes non-shockable.

If the device detects several consecutive strips that are non-shockable, it will give a voice prompt that no shock is advised and inform the user that it is safe to touch the patient, and pause. During the default SMART NSA (no shock advised) pause, the device conducts background monitoring and, if a potentially shockable rhythm is detected in a motionless patient, terminates the SMART NSA pause and resumes rhythm analysis. If the device detects CPR in progress or if the responder has pressed the i-button for CPR Coaching, the SMART NSA pause will be converted to a standard NSA pause, and does not perform rhythm analysis during the pause.

SPECIFIC ANALYSIS EXAMPLES

This method of analysis is applied to the four different ECG examples displayed on the following pages. Each ECG is graphed based on its score for stability, conduction, and rate to determine if a shock is advised or not advised by the algorithm. In the graph below, the shock criteria plane is drawn in grey; any dot above the plane represents a shockable rhythm according to the algorithm, and any dot below is considered a non-shockable

rhythm. Green dots indicate a non-shockable rhythm for the NSR and SVT rhythms, and red dots indicate a shock advised for the polymorphic VT and VF rhythms.

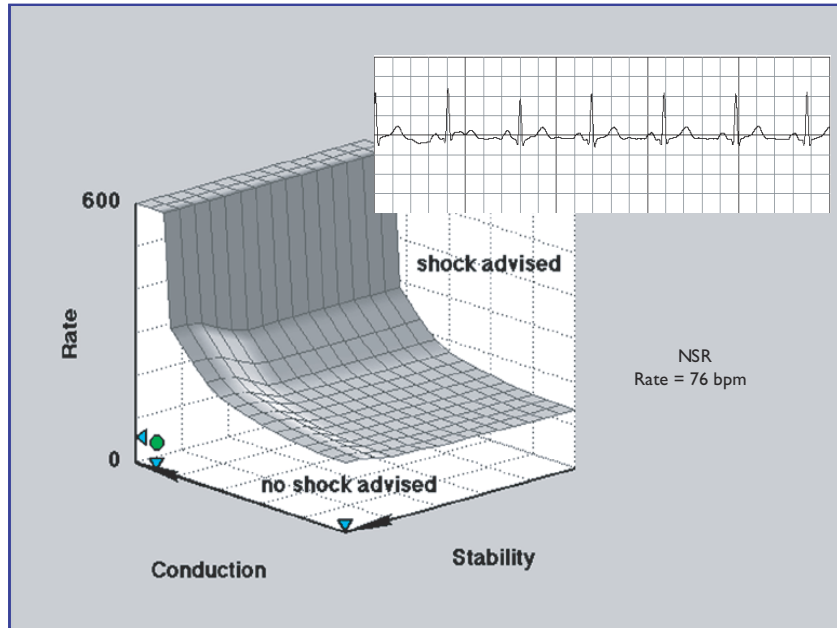

Normal Sinus Rhythm: No-shock advised - excellent stability, conduction, and rate

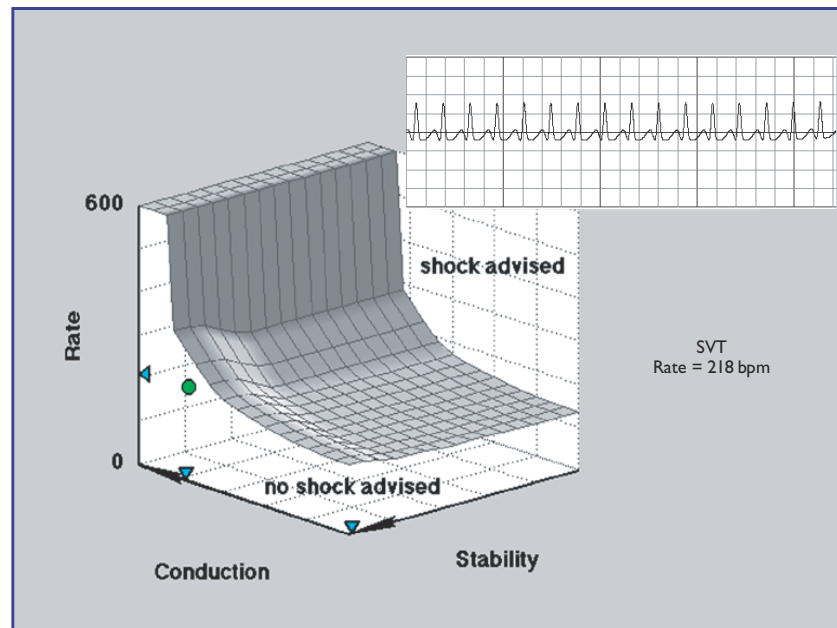

SVT: No-shock advised - excellent stability and conduction, high rate

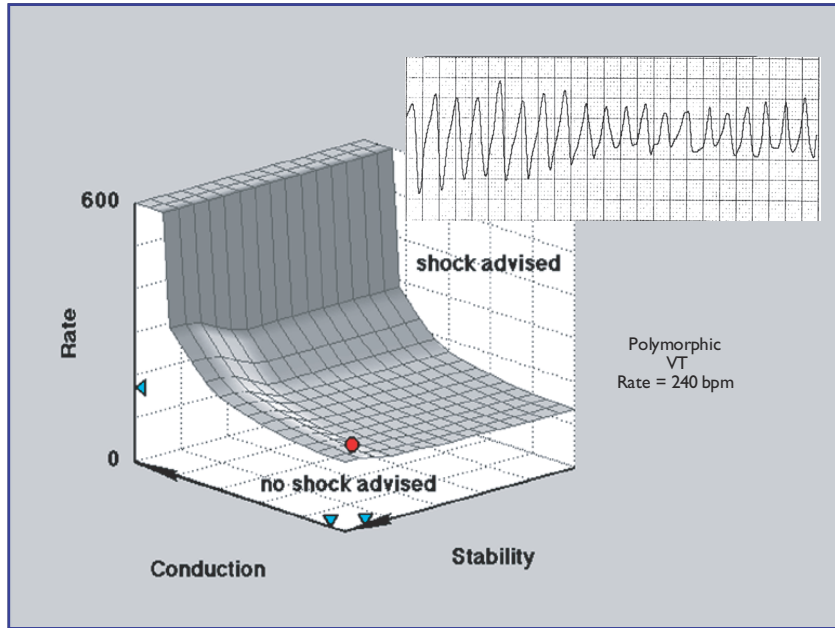

Polymorphic VT: Shock advised - poor stability, very poor conduction, high rate

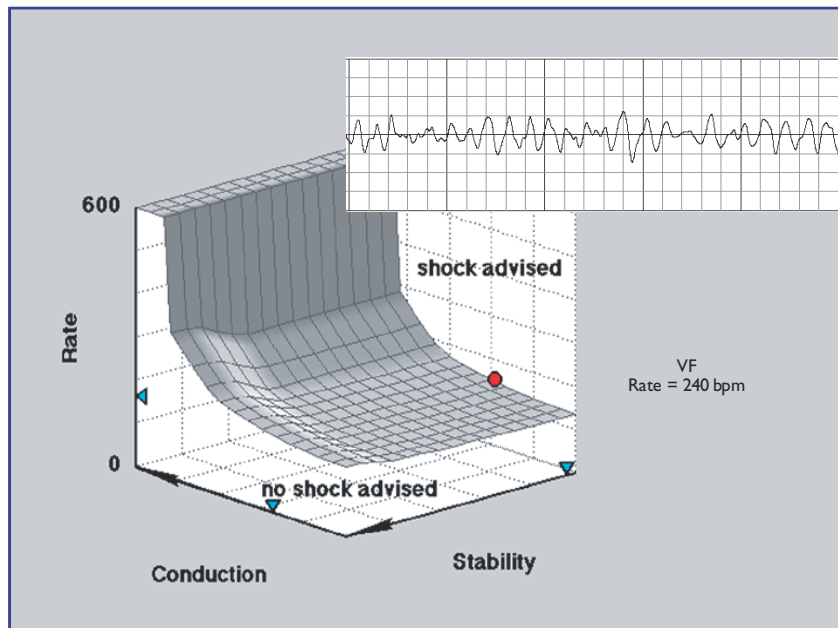

Ventricular fibrillation: Shock advised - very poor stability and conduction, high rate

Sensitivity and Specificity

In 1997, the American Heart Association published a Scientific Statement¹ that recommends a strategy for evaluating the accuracy of the arrhythmia analysis algorithms incorporated in AEDs. Following the process described in this recommendation, over 3000 ECG strips were collected into a database. This database included both shockable and non-shockable rhythms, and was used to design and validate the SMART Analysis system used in the HeartStart AEDs.

Each strip was reviewed by a group of three cardiologists to determine whether that strip should be considered shockable or non-shockable. If there was disagreement on a particular strip, the cardiologists were asked to discuss the strip and come to a consensus on how to classify the strip. By far, the most disagreements resulted from ventricular tachycardia (VT) strips and were related to whether it was appropriate for an AED to shock this type of VT.

In the following graph, each of the 3000 strips was plotted according to the same criteria as the specific examples discussed above (stability, conduction and rate). If the dot is red, it was considered a shockable rhythm by the cardiologists; if it is green, it was considered a non-shockable rhythm.

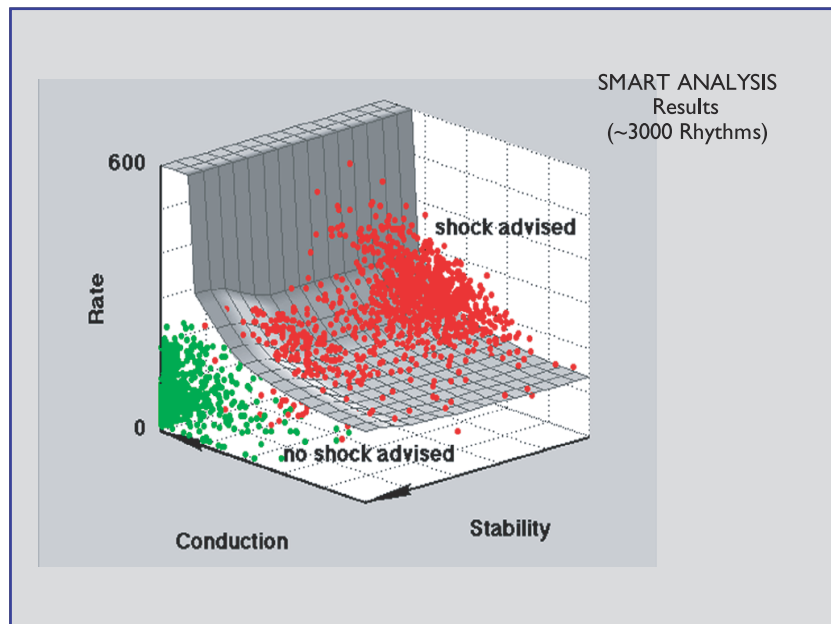

Plot of evaluated ECGs shock/no shock decisions against the SMART Analysis parameters

1. Automatic external defibrillators for public access defibrillation: recommendations for specifying and reporting arrhythmia analysis algorithm performance, incorporating new waveforms, and enhancing safety. *Circulation*. 1997;95:1677-1682.

The SMART Analysis algorithm was designed to make aggressive shock decisions concerning VF but to make conservative decisions about shocking VT rhythms that may have an associated pulse. The graph above shows only red dots above the shock-criteria plane, indicating that a shock will be advised only if it is needed.

The figure shows some red dots that fall below the shock criteria plane. In these instances, the algorithm did not advise a shock, but the cardiologists concluded that a shock should be advised. These rhythms are typically intermediate VT that may have some perfusion associated with them. If they are non-perfusing rhythms, they will quickly degrade to the point that they will migrate above the shock-criteria plane and the SMART Analysis system will advise a shock. If the shock criteria were changed so that the plane was shifted to try to catch more of the shockable rhythms below the plane, the algorithm would also advise a shock for a greater number of non-shockable rhythms. The SMART Analysis system was intentionally designed to be conservative in this respect because the specificity of AED algorithms is required to be high.

While rate is a key factor, it is not the only factor. The more normal the conduction and stability of the QRS complexes, the greater the possibility of perfusion, and the less likely the SMART Analysis system will be to recommend a shock. For example, if a patient, such as an infant with a fast normal sinus rhythm, should have a heart rate of 250 bpm with excellent conduction and stability, the SMART Analysis system would correctly not advise a shock.

SHOCKABLE RHYTHMS

SMART Analysis is designed to shock ventricular fibrillation (VF), ventricular flutter, and polymorphic ventricular tachycardia (VT). These are the most common rhythms associated with sudden cardiac arrest. In addition, it is designed to avoid rhythms that are commonly accompanied by a pulse or rhythms that would not benefit from an electrical shock. The AHA states that rhythms accompanied by a pulse should not be shocked because no benefit will follow and deterioration in rhythm may result.¹

The algorithm used in HeartStart AEDs is different from the algorithm used in the HeartStart manual defibrillators, such as the HeartStart XL and MRx. AEDs are designed to be used by lay rescuers, whereas manual defibrillators are designed to be used by trained medical personnel. The main difference is that the algorithm in an AED should try to differentiate between ventricular tachycardia that has a pulse and one without. The consequence of this is that the HeartStart AEDs are more conservative in shocking intermediate

1. American Heart Association (AHA) AED Task Force, Subcommittee on AED Safety & Efficacy. Automatic External Defibrillators for Public Access Use: Recommendations for Specifying and Reporting Arrhythmia Analysis Algorithm Performance, Incorporation of New Waveforms, and Enhancing Safety. *Circulation* 1997;95:1677-1682.

rhythms such as fine VF and VT that don't meet all criteria for inclusion in the shockable VT rhythm category.

SMART Analysis has been designed to be conservative for stable monomorphic tachycardias. The rate threshold for a shockable tachycardia will vary from a minimum of about 160 bpm for rhythms with very slow ventricular-like conduction to a maximum threshold of 600 bpm for rhythms with healthy normal conduction. Thus, rhythms with normal conduction will not be shocked regardless of the rate.

The AHA has issued a Scientific Statement clearly identifying SVT as a non-shockable rhythm, and requiring a minimum defibrillator algorithm specificity of 95% for this rhythm.¹ This high-specificity requirement assumes that a high-quality assessment of perfusion status has been made, thereby eliminating many SVTs from analysis by the defibrillator. The HeartStart AED is designed to issue a no-shock recommendation for rhythms of supraventricular origin regardless of their rate, and has demonstrated 100% specificity when tested against a database containing 100 examples of SVT with rates as high as 255 beats per minute.

For rhythms that have poorer morphological stability such as polymorphic VT and VF, the rate threshold varies in a similar manner described above. As morphological stability degrades, the rate threshold will be progressively reduced, approaching a minimum rate threshold of about 135 bpm.

This adaptive design allows the rate threshold to be varied from a minimum level for the most lethal VF rhythms, providing very high sensitivity, to increasingly higher rate thresholds as the stability or conduction characteristics approach normal, providing very high specificity. Borderline rhythms, such as monomorphic tachycardias are treated conservatively, with the expectation that if they are hemodynamically unstable, then the rhythm will soon exhibit shockable characteristics.

Two samples of monomorphic tachycardia are shown below as examples of borderline rhythms that do not require shocks. Both of these rhythms are of supraventricular origin, with one known to be accompanied by a pulse. SMART Analysis gives a no-shock recommendation for both of these rhythms.

1. Kerber RE, et al. Automatic external defibrillators for public access defibrillation: Recommendations for Specifying and reporting arrhythmia analysis algorithm performance, incorporating new waveforms, and enhancing safety: a statement for health professionals from the American Heart Association Task Force on Automatic External Defibrillation, Subcommittee on AED Safety and Efficacy. *Circulation*. 95(6):1677-1682, March 18, 1997.

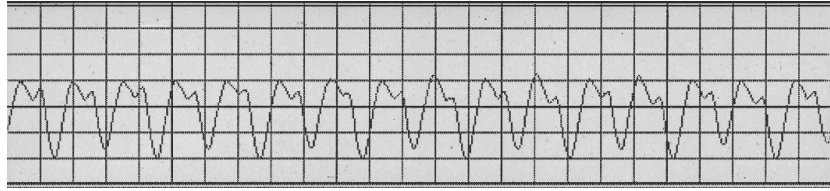

Rate ~ 192 bpm

No Shock Advised

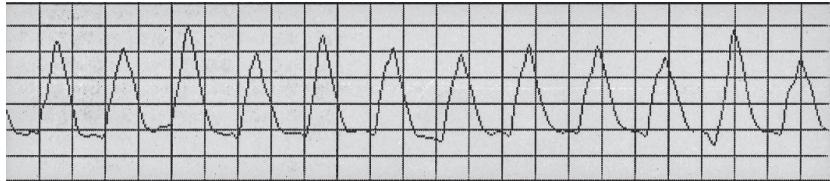

Rate ~ 144 bpm

No Shock Advised

The next two samples are examples of polymorphic VT and flutter. These rhythms represent ECGs that are not associated with a pulse and are considered shockable forms of VT.

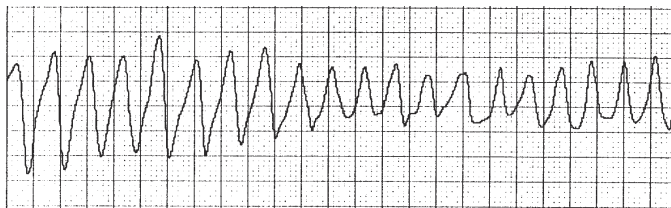

Rate ~ 240 bpm

Shock Advised

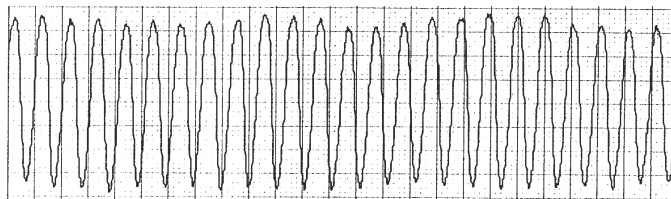

Rate ~ 288 bpm

Shock Advised

The HSI AED *Owner's Manual* states that, for safety reasons, some very low-amplitude or low-frequency rhythms may not be interpreted as shockable VF rhythms. Also some VT rhythms may not be interpreted as shockable rhythms. As noted earlier in this chapter, low-amplitude or low-frequency VF may sometimes be the result of patient handling, and some VT rhythms have been associated with a pulse.

The next example of VF shown would not be considered a shockable rhythm because of its low frequency. In addition to the possibility of patient handling generating this type of rhythm, there are studies that indicate that a fine VF such as this would benefit from a minute or two of CPR before a shock is attempted. CPR tends to oxygenate the myocardium and increase the electrical activity of the heart, making it more susceptible to defibrillation.

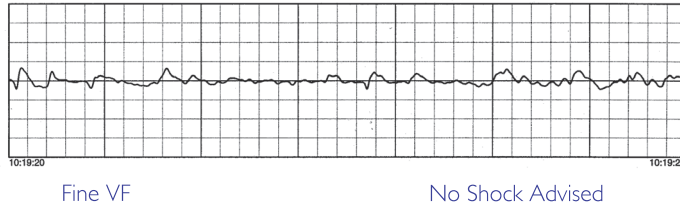

VALIDATION OF ALGORITHM

Algorithm performance is evaluated by two criteria: sensitivity, which is the ability of the algorithm to detect life-threatening ventricular arrhythmias, and specificity, which is the ability of the algorithm to discriminate life-threatening arrhythmias from normal rhythms or arrhythmias that should not be shocked. We developed a proprietary electrocardiogram (ECG) analysis system that provides an exceptional level of sensitivity and specificity.

PHILIPS MEDICAL SYSTEMS

rhythm class	HeartStart AED validation results ^a meets AHA recommendations ^b for adult defibrillation				
	AAMI DEF80 requirement ^b	observed performance validation results ^c	artifact-free	artifact included	90% one-sided lower confidence limit ^b
shockable rhythm — ventricular fibrillation	sensitivity >90%	97% (n=300)	99.1% (n=106)	97.3% (n=111)	(87%)
shockable rhythm — ventricular tachycardia	sensitivity >75%	81% (n=100)	100% (n=9)	90% (n=10)	(67%)
non-shockable rhythm — normal sinus rhythm	specificity >99%	100% (n=300)	100% (n=15)	100% (n=17)	(97%)
non-shockable rhythm — asystole	specificity >95%	100% (n=100)	100% (n=53)	100% (n=64)	(92%)
non-shockable rhythm — all other non-shockable rhythms	specificity >95% includes: SVT (R>100), SVD (R≤100), VEB, idioventricular, and bradycardia	100% (n=450)	99% (n=101)	95.6% (n=114)	(88%)

- a. The studies and data cited above are the result of extremely challenging rhythms that deliberately test the limits of AEDs. In clinical situations, the actual sensitivity and specificity for the HeartStart AEDs have been significantly better, thereby validating Heartstream's rigorous pre-market testing of its algorithm.
- b. American Heart Association (AHA) AED Task Force, Subcommittee on AED Safety & Efficacy. Automatic External Defibrillators for Public Access Use: Recommendations for Specifying and Reporting Arrhythmia Analysis Algorithm Performance, Incorporation of New Waveforms, and Enhancing Safety. *Circulation* 1997;95:1677-1682.
- c. From Philips Medical Heartstream ECG rhythm databases.

In the original, out-of-hospital study involving 100 patients,¹ the SMART Analysis system correctly identified all patients in VF (100% sensitivity) and correctly identified and did not shock all patients in non-VF rhythms (100% specificity). Borderline rhythms are reviewed periodically to determine if the algorithm should be fine-tuned in future products.

In preparation for introducing the pediatric defibrillation electrodes for the HeartStart AED, a database was assembled that included 696 pediatric arrhythmias. When the HeartStart SMART Analysis system was tested on the ECG strips in this database, the authors of the study concluded, “There was excellent AED rhythm analysis sensitivity and specificity in all age groups for ventricular fibrillation and non-shockable rhythms. The high specificity and sensitivity indicate that there is a very low risk of an inappropriate shock and that the AED correctly identifies shockable rhythms, making the algorithm both safe and effective for children.”²

SPECIFIC CONCERNS FOR ADVANCED USERS OF HEARTSTART AEDS

HEARTSTART AED VS. HEARTSTART ALS DEFIBRILLATOR ALGORITHMS

The algorithm designed specifically for HeartStart AEDs differs somewhat from the algorithm designed for HeartStart ALS defibrillators, such as the XL and the MRx. AEDs are designed to be used by lay rescuers as well as trained EMS personnel and medical professionals, whereas manual defibrillators are designed to be used only by trained medical personnel. Because AEDs are designed to be used in circumstances that require delivery of therapy without the advice of a medical professional, the algorithm must differentiate between pulsed and pulseless ventricular tachycardia.

It is important for Medical Directors of defibrillator programs to be aware of these differences in rhythm analysis. HeartStart AEDs are more conservative in shocking intermediate rhythms such as fine VF and VT that do not meet all criteria for inclusion in the shockable VT rhythm category. Therefore, HeartStart ALS defibrillators will advise a shock on some VT rhythms that the HeartStart AEDs consider non-shockable. This difference may affect decisions concerning the deployment of both AEDs and ALS defibrillators and the kind of training provided for their use.

Simulator Issues with SMART Analysis

ECG simulators are designed to train people to recognize different heart rhythms based on a visual analysis of the data and cannot be used to verify

1. Jeanne Poole, M.D., et al. Low-energy impedance-compensating biphasic waveforms terminate ventricular fibrillation at high rates in victims of out-of-hospital cardiac arrest,” *Journal of Cardiovascular Electrophysiology*, December 1997.
2. Cecchin F, et al. Is arrhythmia detection by automatic external defibrillator accurate for children? *Circulation*, 2001; 103:2483-2488.

defibrillator analysis algorithms. Simulators contain simulated waveforms and typically have only one example of each type of rhythm. In addition, these devices only store a few seconds of ECG signal that is repeated over and over again. This apparent stability can cause the HeartStart AED to not advise a shock even though the simulator-generated rhythm may appear shockable to the user.

The conduction and stability characteristics of a simulated VT waveform frequently appear to be high and repeatable. Also, the shape of the simulator's QRS complexes may be fairly sharp, indicating possible perfusion and causing the SMART Analysis system to determine that the rhythm is not shockable. A monomorphic VT must have a relatively high rate and poor conduction to be considered shockable by the SMART Analysis system. Polymorphic VTs are considered shockable at lower rates because there is variation in the shape of the QRS complexes.

Most simulated VF signals will be interpreted as shockable by HeartStart defibrillators. However, most VT rhythms found in simulators are monomorphic VT and will not be considered shockable because the shape and regularity of the waveform indicate that there may be a pulse associated with it.

[Use of External Pacemakers with Internal Leads](#)

In some countries, it is common practice after open-heart surgery to leave internal leads on the heart to be used with an external pacing device if needed during recovery. These external pacers have different characteristics from implantable pacemakers and can, therefore, interfere with proper analysis of an AED algorithm.

External pacing and defibrillation are two different therapies and should not be performed at the same time. If an external pacer is being used on a patient who goes into cardiac arrest, the pacer should be turned off or disconnected from the patient before the AED is applied to the patient. Failure to do so may result in delayed or incorrect analysis by the AED.

5 OTHER FEATURES

OVERVIEW

HSI defibrillators are in service throughout the world. They are designed to make ownership and use as simple as possible.

SELF-TESTS

The HeartStart HSI AEDs are designed to minimize required maintenance by using extensive self-tests to simplify the maintenance process. The user is not required to perform calibration or energy verification before the HSI is put into service or at regular intervals. Maintenance testing is not required because the HSI automatically runs a self-test at least once per day. By visually checking the Ready light daily, the user can verify that the HSI has passed a self-test within the last 24 hours and is therefore ready for use.

BATTERY INSERTION TEST

When a user installs a battery in the HSI AED, the device runs a comprehensive self-test, called a Battery Insertion Test (BIT). The BIT verifies that the AED circuitry is fully operational, the device is properly calibrated, and that the device is operating within its performance specifications.

The BIT should not be performed on a regular basis since this is unnecessary and shortens the life of the battery. It is recommended that the full BIT be run only under the following conditions:

- When the HeartStart HSI is first put into service and following each emergency use.
- Whenever the battery is replaced (except when the HSI is in use on a patient).
- Whenever expired pads are replaced during periodic maintenance.
- Whenever the HSI may have sustained physical damage.

READY LIGHT

The Ready light, located on the upper right face corner of the HSI, indicates the readiness of the device.

If the green LED Ready light is blinking: the HSI has passed the battery insertion self-test and the last periodic self-test and is therefore ready for use.

If the green Ready light is solid: The HSI is in use or running a self-test.

A blinking green Ready light in the upper right of the HeartStart HSI defibrillator means that it has passed its most recent self-test (within 24 hours) and is ready for use. The green Ready light blinks once every three seconds.

If the HeartStart HSI detects a problem during a self-test, the Ready light will stop blinking. The defibrillator will sound an alert by chirping while the blue i-button blinks once every eight seconds. If your AED emits a pattern of single chirps, please press the flashing blue i-button on the front of the device. The defibrillator will provide voice prompts that identify the problem and provide troubleshooting instructions.

If at any time during the life of the device, your HeartStart HSI AED emitted or begins to emit a pattern of triple chirps, it is important that you remove the device from use, and contact your local Philips representative. If the AED emits a pattern of triple chirps, it is a signal that the device requires investigation by Philips to ensure that it is ready for use. Of course, if needed for use in an emergency, make every attempt to clear the error and use the device normally, as described in the *Owner's Manual*. However, even if you have been able to clear the error, it is important that you contact your local Philips representative to obtain the tools and information you need to ensure that your device is functioning properly.

Note that if the battery is completely depleted, or if the unit stops functioning, the defibrillator may not emit chirps, and the blue i-button may not blink.

PERIODIC SELF-TESTS

As long as a battery is installed and the pads case is connected, the HSI AED automatically performs a self-test at least once every 24 hours. An exception to this is when the unit is stored outside of its operating temperature range, which is indicated on the HSI by alarm chirping and a flashing blue i-button. If you press the blue i-button, the device will tell you that it could not complete its self-test because it has been stored outside its temperature range. The HSI will wait until its temperature is within specified limits before it resumes self-testing. This allows it to automatically reschedule self-testing to avoid, for example, a particularly cold time of night.

There are three different periodic self-tests: daily, weekly, and monthly. The main difference among these tests is the extent of front end and waveform delivery circuitry tested and the energy level used. The monthly periodic self-test is the equivalent of the BIT, but without the user interactive part of the test. Test coverage is shown in Table I, below.

During the tests, the various lights on the device will briefly light and the unit may emit a soft click as its relays are tested. If the HSI is stored in its carrying case, it is unlikely that any of this will be noticeable.

A blinking green Ready light means that the HeartStart HSI AED has passed a self-test within the last 24 hours and is therefore ready for use. If a written record of the periodic check is required, the visual check can be noted in an operator's checklist. In addition, HeartStart Event Review Software, available from Philips, can be used to print a self-test report for the HeartStart HSI AED.

TESTS PERFORMED PERIODICALLY

HSI AED SUBSYSTEM	TEST	WHEN TEST IS PERFORMED				
		BIT	PIT	DPST	WPST	MPST
computer and data processing	Computer Processor and Memory Test — Verifies that the computer processors and system memory are operating properly.	✓	✓	✓	✓	✓
pads	Pads Integrity Test — Verifies that installed pads are in good condition. Assesses readiness for use based on gel moisture			✓	✓	✓
	Pads Identification Test — Verifies the cartridge type and that it is correctly installed.	✓	✓	✓	✓	✓
shock delivery	Device Functionality Test — Verifies that the systems responsible for interpreting the electrocardiogram (ECG) signal are operating appropriately and ensures that all systems used to deliver the shock are functioning properly.	✓		✓	✓	✓
power supply	Power Supply Test — Verifies the power supply system is operating properly.	✓		✓	✓	✓
calibration	Voltage Reference Test — Verifies that the voltage used for internal reference is correct	✓		✓	✓	✓
	High-Voltage Calibration Test — Ensures that the system that delivers the shock is using the correct parameters. Charges and discharges the capacitor to verify correct energy delivery.	✓				✓
	ECG Calibration Test — Ensures that the systems responsible for interpreting the electrocardiogram (ECG) signal are using accurate references.	✓			✓	✓

HSI AED SUBSYSTEM	TEST	WHEN TEST IS PERFORMED				
		BIT	PIT	DPST	WPST	MPST
user interface	User Interface Test — Prompts the user to verify that the Shock button and speaker are operating.	✓				
	Button Test — Automatically verifies that the Shock button, On/Off button, and Information button (i-button) are not stuck and are ready for use.	✓		✓	✓	✓
	Audio System Test — Verifies that the audio drivers and sound files are working properly.	✓			✓	✓

TESTS PERFORMED CONTINUOUSLY

In addition to periodic tests, the device continuously executes a series of tests to check its basic safety and readiness for use. These continuous tests are collectively called the Run Time Self-Tests (RTST). These tests occur whenever the device is powered on, including running while other self-tests such as BITs or DPSTs are being performed. Therefore, these tests are performed in addition to any periodic self-test. For example, the battery capacity will be tested by the RTST while the DPST is being performed. The continuous RTST includes checks of:

TEST	DESCRIPTION
battery capacity	Measures remaining battery capacity to warn user if the battery becomes low or if the device is stored outside the standby temperature ranges.
power supply	Verifies that the power supply is producing the correct voltage
ecg	Checks if pads are attached to a patient and if the device is receiving a recognizable ECG signal.
shock engine	Verifies that the power discharge system is ready for use.
software	Ensures internal programs are communicating with each other.

CUMULATIVE DEVICE RECORD

The Cumulative Device Record (CDR) contains a list of the events that the HSI AED has experienced during the life of the device. The first event is stored when the software is loaded during the manufacturing process. Each time the device is turned on, one or more events are appended to this list.

The CDR was designed primarily for troubleshooting purposes and stores the results of each self-test in non-volatile memory in the HSI. Although the CDR does not contain any ECG information, it stores information from each use of the device such as the elapsed time of the use, number of shocks delivered, pads condition, and the number of shock and no-shock decisions made during each use.

This information is relatively easy to download, but was not designed for interpretation by the user. In the troubleshooting process, Philips will occasionally ask a customer to download the information to Event Review (version 3.5 or higher) and transmit it to Philips to be analyzed by Philips personnel.

SUPPLEMENTAL MAINTENANCE INFORMATION FOR TECHNICAL PROFESSIONALS

Background

Technical Professionals occasionally request supplemental information about maintaining the HSI AED. This document is intended to supplement the User information for HSI use and maintenance provided by the HSI *Owner's Manual* (REF M5066-91901).

This Supplemental Technical Information is intended for use by Technical Professionals and addresses calibration requirements and intervals, maintenance testing, verification of energy discharge, and service/maintenance and repair manual.

CALIBRATION REQUIREMENTS AND INTERVALS

Users frequently ask about the requirement to calibrate and/or verify energy delivery. The HSI AED does not require user calibration or verification of energy delivery prior to placing it in service. Further, the HSI does not require user calibration at regular intervals, including annual intervals.

MAINTENANCE TESTING

Maintenance testing is unnecessary, as the HSI automatically perform daily self-tests, and correct operation is verified during battery insertion tests.

When the Ready light is blinking that daily, weekly and monthly self-tests are operating as scheduled and that the unit has passed the most recently scheduled self-test.

VERIFICATION OF ENERGY DISCHARGE

The HSI does not require manual verification of energy delivery because monthly automatic self-tests verify the waveform delivery system. However, a qualified technical professional can test HSI energy delivery, using instructions available from Philips. Improper testing can seriously damage the HSI and render it unusable.

SERVICE/MAINTENANCE AND REPAIR MANUAL

The HSI AED has no user serviceable parts, and Philips is the sole repair facility for the unit. As a result, Philips does not publish Service/Maintenance and Repair Manuals for this product. Customer Service contact: 800-263-3342, 206-664-7745.

CPR COACHING

The default factory configuration of the HSI AED includes CPR Coaching. This feature provides basic verbal instructions for performing cardiopulmonary resuscitation, including hand placement, rescue breathing, compression depth and timing.

After completion of any shock series (the default shock series is a single shock), a two-minute protocol pause for CPR automatically starts. Similarly, after any no-shock-advised (NSA) decision, an NSA pause is provided. For the first 30 seconds of either of these patient care pauses, the blue i-button flashes. If the user presses the i-button for optional CPR coaching, the HSI provides coaching for 5 cycles of CPR, starting and ending with compressions, when the CPR Coaching parameters are also set to their default values. The number of CPR cycles varies for other NSA pause timer and CPR Coaching parameter settings.

QUICK SHOCK

The HeartStart HSI is able to deliver a shock in less than 8 seconds, typical, following a patient care pause.

It is now well known that for longer down time patients, e.g., longer than 5 minutes, good CPR prior to defibrillation shock can help restore a normal heartbeat in more patients.^{1,2} The beneficial effect of CPR disappears very rapidly once it is stopped, so time to shock is very important.^{3,4}

Quick Shock helps by reducing the interruption of CPR chest compressions and increasing the chance that a shock will result in a successful return to spontaneous circulation. Two independent articles published in *Circulation* support Quick Shock. In one article, Dr. Yu et al, concluded, “Interruptions of precordial compression for rhythm analyses that exceed 15 seconds before each shock compromise the outcome of CPR and increase the severity of post resuscitation myocardial dysfunction.”³ A second study by Dr. Eftestol et al., similarly concluded “The interval between discontinuation of chest compressions and delivery of a shock should be kept as short as possible.”⁴ Simply put, getting a shock to the heart as soon as possible after CPR can save more lives.

PEDIATRIC DEFIBRILLATION

If you may need to defibrillate an infant or a child under 55 pounds (25 kg) or 8 years old with a HeartStart HSI Defibrillator, it is recommended that you order the Infant/Child Pads Cartridge, available separately. When the Infant/Child Pads Cartridge is installed in the HSI, the HSI automatically reduces the defibrillation energy to 50 joules and, if optional CPR Coaching is selected, provides coaching appropriate for infants and children.

WARNING: Most cardiac arrests in children are not caused by heart problems. When responding to cardiac arrest in an infant or child:

- Provide infant/child CPR while a bystander calls EMS and brings the HSI.
- If no bystander is available, provide 1-2 minutes of CPR before calling EMS and retrieving the HSI.
- If you witnessed the child's collapse, call EMS *immediately* and *then* get the HSI.

Alternatively, follow your local protocol.

1. Cobb LA, Fahrenbruch CE, Walsh TR, et al. Influence of cardiopulmonary resuscitation prior to defibrillation in patients with out-of-hospital ventricular fibrillation. *JAMA*. 1999 Apr 7; 281(13):1182-8.
2. Wik L, Hansen TB, Fylling F, et al. Delaying defibrillation to give basic cardiopulmonary resuscitation to patients with out-of-hospital ventricular fibrillation: A randomized trial. *JAMA*. 2003 Mar 19; 289(11):1389-95
3. Yu T, Weil MH, Tang W. Adverse outcomes of interrupted precordial compression during automated defibrillation. *Circulation*. 2002; 106:368-372.
4. Eftestol T, Sunde K, Steen PA. Effects of interrupting precordial compressions in the calculated probability of defibrillation success during out-of-hospital cardiac arrest. *Circulation*. 2002;105:2270-2273.

If the victim is under 55 pounds or 8 years old, If the victim is under 55 pounds or 8 years old, but you do not have an Infant/Child Pads Cartridge, do not delay treatment. Use the standard adult SMART Pads Cartridge but place one pad in the center of the chest between the nipples and the other in the center of the back (anterior-posterior).

If the victim is over 55 pounds or 8 years old, or if you are not sure of the exact weight or age, do not delay treatment. Do not use the Infant/Child Pads Cartridge, and place the pads as illustrated on each pad (anterior-anterior). Make sure the pads do not overlap or touch each other.

HEARTSTART TRAINER

The HeartStart Trainer M5085A is designed to prepare emergency responders to use the HSI AED. The HeartStart Trainer resembles the HSI AED but cannot be used to deliver defibrillation treatment. It provides simulated shock delivery. It has no high-voltage capabilities, ensuring safety during training. The Trainer is powered by four standard AA alkaline batteries.

The HeartStart Trainer is designed for use with training manikins in conjunction with Internal Manikin Adapter M5088A or External Manikin Adapter M5089A and with Adult Training Pads Cartridge M5073A or Infant/Child Training Pads Cartridge M5074A only. Replacement adult and infant/child training pads are available for repacking in the Training Pads Cartridges.

The HeartStart Trainer and Adult Training Pads Cartridge can also be used with an Adult Pads Placement Guide M5090A. The Trainer and Infant/Child Training Pads Cartridge can be used with an Infant/Child Pads Placement Guide 989803139281 for training in pediatric defibrillation.

The HeartStart Trainer provides a variety of simulations, or training scripts, to help responders become familiar with the HSI defibrillator and allow them to practice the basic skills necessary to use the defibrillator in an emergency. The default Trainer configuration can be adjusted to meet local protocol requirements.

TRAINING SCENARIOS



The HeartStart Trainer has eight training scenarios that simulate realistic sudden cardiac arrest episodes. These scenarios are compatible with training programs developed by nationally recognized responder programs. The Trainer's setup is configured to meet Guidelines 2005¹ standard protocols and cannot be reconfigured.

1. 2005 American Heart Association Guidelines for Cardiopulmonary Resuscitation and Emergency Cardiovascular Care. *Circulation* 2005;112:IV. European Resuscitation Council Guidelines for Resuscitation 2005. *Resuscitation* 2005;67S1:S7-S23. International Liaison Committee on Resuscitation. *Resuscitation* 2005;67:203-211.





When the Trainer directs you to press the Shock button, the scenario will not advance unless the button is pressed. When the Trainer detects a non-shockable rhythm, it instructs you to provide CPR. In the Trainer scenarios, “conversion” means a change from a shockable to a non-shockable rhythm.

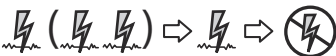

The legend below identifies the symbols used on the rear label of the HeartStart Trainer and in the following scenario descriptions. In the Trainer scenarios, “conversion” means a change from a shockable to a non-shockable rhythm.

NOTE: The Trainer provides a two-minute CPR/patient care interval after each shock delivery and each No Shock decision

SYMBOL	MEANING
	(Simulated) shockable rhythm detected by Trainer.
	(Simulated) non-shockable rhythm detected by Trainer.
	(Simulated) pads problem detected by Trainer.

SCENARIO NUMBER	SCENARIO DESCRIPTION
<p>Scenario 1</p> 	<p>Shockable rhythm detected, one shock needed for conversion</p> <p>Details:</p> <ul style="list-style-type: none"> Trainer detects a shockable rhythm, instructs user to deliver a shock. Trainer detects a non-shockable rhythm.
<p>Scenario 2</p> 	<p>Shockable rhythm detected, multiple shocks needed for conversion</p> <p>Details:</p> <ul style="list-style-type: none"> Trainer detects a shockable rhythm, instructs user to deliver a shock. Trainer still detects a shockable rhythm, instructs user to deliver another shock. Trainer detects a non-shockable rhythm.

SCENARIO NUMBER	SCENARIO DESCRIPTION
<p style="text-align: center;">Scenario 3</p> 	<p>Troubleshooting pads, one shock needed for conversion</p> <p>Details:</p> <ul style="list-style-type: none"> • Trainer detects poor pad contact, repeats pads placement instructions. • After one pad is removed and reapplied, Trainer detects a shockable rhythm, instructs user to deliver a shock. • Trainer detects a non-shockable rhythm.
<p style="text-align: center;">Scenario 4</p> 	<p>Shockable rhythm detected, conversion, return to shockable rhythm, conversion</p> <p>Details:</p> <ul style="list-style-type: none"> • Trainer detects a shockable rhythm, instructs user to deliver a shock. • Trainer detects a non-shockable rhythm. • Trainer detects refrillation (return to a shockable rhythm), instructs user to deliver a shock. • Trainer detects a non-shockable rhythm.
<p style="text-align: center;">Scenario 5</p> 	<p>Non-shockable rhythm detected</p> <p>Details:</p> <ul style="list-style-type: none"> • Trainer detects a non-shockable rhythm throughout.
<p style="text-align: center;">Scenario 6</p> 	<p>Shockable rhythm detected, two shocks needed for conversion</p> <p>Details:</p> <ul style="list-style-type: none"> • Trainer detects a shockable rhythm, instructs user to deliver a shock. • Trainer still detects a shockable rhythm, instructs user to deliver another shock. • Trainer detects a non-shockable rhythm.

SCENARIO NUMBER	SCENARIO DESCRIPTION
<p style="text-align: center;">Scenario 7</p> 	<p>Shockable rhythm detected, two shocks needed for conversion, return to shockable rhythm detected, one shock needed for conversion</p> <p>Details:</p> <ul style="list-style-type: none"> • Trainer detects a shockable rhythm, instructs user to deliver a shock. • Trainer still detects a shockable rhythm, instructs user to deliver another shock. • Trainer detects a non-shockable rhythm. • Trainer detects refrillation (return to a shockable rhythm), instructs user to deliver a shock. • Trainer detects a non-shockable rhythm.
<p style="text-align: center;">Scenario 8</p> 	<p>Troubleshooting pads, two shocks needed for conversion</p> <p>Details:</p> <ul style="list-style-type: none"> • Trainer detects poor pad contact, repeats pads placement instructions. • After one pad is removed and reapplied, Trainer detects a shockable rhythm, instructs user to deliver a shock. • Trainer still detects a shockable rhythm, instructs user to deliver another shock. • Trainer detects a non-shockable rhythm.

IMPORTANT: Certain features of the actual HeartStart HSI Defibrillator are not reproduced by the HeartStart Trainer.

- The Trainer cannot be used with the (clinical) SMART Pads cartridges. If a SMART Pads cartridge is installed, the Trainer will repeatedly request the user to install a new cartridge.
- The Trainer does not perform the battery insertion and periodic self-tests.
- The Trainer's setup is configured to meet Guidelines 2005 standard protocols and cannot be reconfigured.
- The Trainer always uses a standard NSA (No Shock Advised) pause.

6 THEORY OF OPERATION

IMPORTANT NOTE: The internal construction of all HeartStart AEDs is extremely sophisticated. They require special fixtures for assembly in order to achieve their compact size and shape while ensuring a durable environmental seal. The AEDs also contain high-voltage circuits that can present a safety risk if improperly handled. As a result, HeartStart AEDs are not designed to be opened in the field; they must be returned to the factory for any repair. All service for the AED is done via an exchange program with the factory.

OVERVIEW

The theory of operation presented here in brief is provided solely to give the user a better understanding of how the HeartStart HSI automated external defibrillators (AEDs) work.

The HeartStart HSI AED monitors the patient's electrocardiogram (ECG) and advises the user to deliver a shock when appropriate. In order to do this, the HSI has to perform a number of functions, including:

- Input the ECG signal and convert it into a digital format that the microprocessor can analyze.
- Analyze the ECG and determine if the device should charge and allow a shock to be delivered.
- Charge the internal capacitor to a voltage high enough to effectively defibrillate the patient.
- Instruct the user to deliver the shock.
- Provide the proper switching inside the device to deliver a controlled shock when the shock button is pressed.
- Provide CPR Coaching, if so configured.
- Repeat this process if necessary.

Because HeartStart HSI AEDs are designed to permit use by rescuers who are not trained to read ECGs and to distinguish between shockable and non-shockable rhythms, the device must also:

- Supply voice prompts to instruct the user in operating the device and assisting the patient.
- Provide audio and visual indicators to call attention to various parts of the device at appropriate times (e.g., Shock button light, Ready light, low battery warning).
- Automate the maintenance process to ensure the device is ready to use when needed.
- Store the ECG and event data to be reviewed at a later time.

The block diagram shown below indicates the major components of the HeartStart HSI AED. These include:

- User interface
- Control Board
- Battery
- Power supply
- ECG Front End
- Patient Circuit (high-voltage charger, high-voltage capacitor, switching/isolation circuitry)

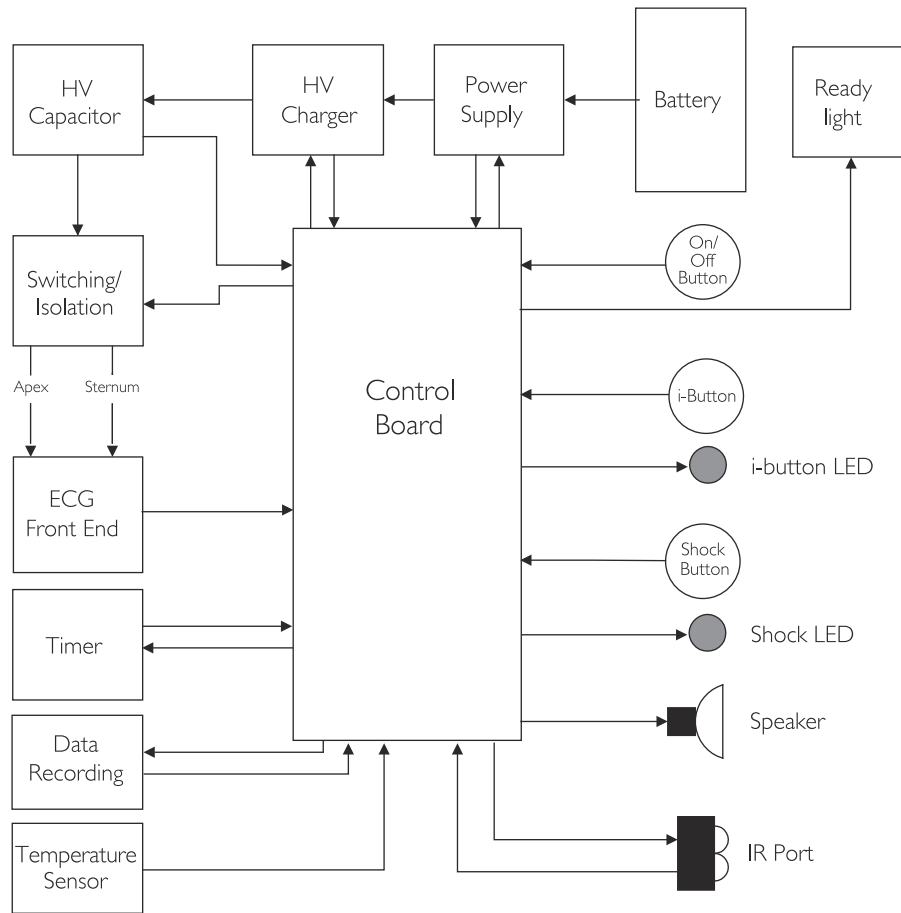

HeartStart HSI block diagram

USER INTERFACE

The user interface of the HSI AED consists of the On/Off button, the PULL handle of the SMART Pads Cartridge, the Shock button, the i-button, the speaker, and the Ready light.

OPERATION

In normal operation, voice prompts are provided through the speaker. These prompts guide the rescuer in the use of the device and give warnings (such as low battery) to call the user's attention to certain parts of the device that may need attention. If the HSI advises a shock and charges, the Shock button will flash to help guide the user's attention to the shock button and indicate that it is ready to deliver a shock to the patient. The HSI also starts chirping when the device needs attention. At these times, the blue i-button will be flashing. When the user presses the i-button, the HSI will provide a voice instruction regarding the problem.

MAINTENANCE

Maintenance for the HeartStart HSI Defibrillators primarily consists of the user checking the Ready light regularly to verify that the unit is working and ready to be used. The HSI will perform an automatic self-test every 24 hours that verifies that the unit is functioning properly. Once a month, this automatic self-test does a full functional check of the unit that includes verifying full energy discharge internally and self-calibration. If the unit fails to pass one of these self-tests, the Ready light will turn off, the HSI will start chirping, and the i-button will flash.

TROUBLESHOOTING

The speaker and Ready light are also used for troubleshooting the HSI AED. The main troubleshooting tools are the flashing blue i-button and the battery insertion test, or BIT.

When the blue i-button is flashing, the user should give it a short press. The HSI will provide information about a problem it has detected.

To initiate a BIT, the battery is removed and then reinserted. The HSI then executes an automatic comprehensive functional test. The automatic part of the BIT takes about a minutes to run. It is followed by an interactive test that allows the user to verify that the On/Off button and Shock button are working. If the HSI passes the BIT, the Ready light will start blinking and the defibrillator will not be chirping.

CONTROL BOARD

The control board holds the main processor and all of the circuitry required to control the real time functions of the HSI AED. The real time control provides the signals needed to sample the ECG data, play the voice prompts and alarm chirps on the speaker, charge the high-voltage capacitor, and deliver the shock to the patient. In addition, the processor on the control board runs all of the data processing for the analysis system.

BATTERY

The power source for the HSI AED is a 9 VDC, 4.2 Ah battery pack. It contains 9 LiMnO₂ battery cells, similar to those used in cameras. The battery pack is non-rechargeable. All battery cells contain chemicals. Recycle the battery pack at an appropriate recycling facility.

POWER SUPPLY

The power supply is used to convert the battery voltage to the various voltages needed to supply the electronics within the HSI AED.

ECG FRONT END

The front end of the HSI AED amplifies and filters the ECG signal input from the electrodes and feeds this signal into the A/D converter. The sampling rate for the A/D converter is 200 Hz, and this digital data is fed into the control board to be used by the analysis system and stored in internal memory.

PATIENT CIRCUIT

This circuitry includes all components (high-voltage charger, high-voltage capacitor, switching/isolation circuitry) needed for the HSI AED to deliver the defibrillation waveform to the patient. A large amount of energy is stored in the battery: enough for 200 shocks. However, this energy is stored in the battery at a low voltage (9 V) that is not effective for a defibrillation shock. In order for a patient to be defibrillated, enough energy for a shock must be transferred to the high-voltage (HV) capacitor at a voltage sufficiently high to make an effective defibrillation waveform (about 1800 VDC for the SMART Biphasic waveform).

When a shock is advised by the HSI, the high-voltage (HV) charger circuit transfers energy stored in the battery to energy stored in the high-voltage capacitor at about 1800 VDC. This voltage is maintained on the capacitor until the shock is delivered, ensuring that the device is ready to deliver the 150 J shock to the patient.

When the shock button is pressed, the HV capacitor is disconnected from the HV charger circuit and connected to the patient through the electrode pads. The switching circuitry then allows the current to flow in one direction,

pad-to-pad through the patient, and then reverses the direction of the current flow for a preset period of time. The duration of the current flow in each direction through the patient is based on the measured patient impedance; it is this bi-directional flow of current that forms the SMART Biphasic waveform.

DATA RECORDING

The HSI automatically stores data about its last clinical use in its internal memory. The stored data can be conveniently transferred to a personal computer or a handheld computer running the appropriate application in the Philips HeartStart Event Review data management software suite. Event Review software is for use by trained personnel only. Information about HeartStart Event Review is available online at www.medical.philips.com/goto/eventreview.

A voice summary of information about the last use of the defibrillator is available by holding the i-button down until it beeps once. The HSI will tell you how many shocks were delivered and how long it has been since it was turned on. Summary data are available anytime the defibrillator is ready for use (the battery and pads are installed, and the defibrillator is not turned on) or while it is actually in use. Removing the battery erases the summary data for the last use.¹

Detailed last-use data stored in internal memory include:

- ECG recordings (a maximum of 15 minutes following pads application²)
- the HSI's status (entire incident)
- the HSI's rhythm analysis decisions (entire incident)
- the elapsed time associated with stored events (entire incident)

The stored data can be conveniently transferred to a personal computer or a handheld computer running the appropriate application in the Philips HeartStart Event Review data management software suite. Event Review software is for use by trained personnel only. Information about HeartStart Event Review is available online www.philips.com/eventreview. Details about data transfer and timing are provided in Event Review documentation.

TEMPERATURE SENSOR

The HSI incorporates a temperature sensor that allows the control board to determine the ambient temperature of the device. This enables the HSI to

1. The HSI automatically stores information about its last clinical use in its internal memory for at least 30 days, so the data can be downloaded to a computer running appropriate Event Review software. (If the battery is removed during this period, the defibrillator retains the files. When the battery is reinstalled, the last-use ECG recording will be kept in defibrillator memory for an additional 30 days.) After this time, the last-use ECG recordings will automatically be erased to prepare for a future use.
2. If ECG recordings from a previous use have not been erased, the maximum time for new ECG recordings may be less.

determine if it is exposed to temperatures outside the recommended storage range that could damage or reduce the life of the defibrillator electrode pads or the battery. If the temperature of the HSI falls outside the recommended range, the resulting error generated causes the Ready light to go off, the HSI to begin chirping, and the i-button to start flashing. Pressing the i-button results in a voice prompt describing the error. This condition will be cleared once the unit returns to the recommended temperature range and an automatic daily self-test is passed. If the device is exposed to extreme temperatures for extended periods of time, permanent damage can occur to the electrode pads and/or the battery.

TIMER

The HeartStartHSI records the elapsed time from the last event. If you leave the battery in the defibrillator after using the defibrillator, then transfer the last-use data to a computer running HeartStart Event Review software, the software will calculate the local date and time of the device use by subtracting the elapsed time from the computer's clock. However, if you remove the battery prior to transferring the data, the HSI will either prompt you to enter the event date manually, or simply use the current date from the computer, depending on the software used.

IR PORT

The HSI incorporates an infrared (IR) port that can be used to communicate with other HSI AEDs or an IR port on a PC. The IR port can be used to send or receive configuration data from a PC running HeartStart Event Review data management software.

OVERVIEW

HeartStart data management software allows the data from an HSI AED use to be reviewed on a PC at a later time. With this software, the user can:

- Download and print out ECG data recorded by the HSI (a maximum of 15 minutes from application of the pads for each incident)
- Review the event data (HSI status, rhythm analysis decisions, and elapsed time) for the entire incident
- Annotate the ECG
- Generate and print reports for analysis and record-keeping
- Merge, review, and archive ECG data recorded on multiple devices for a single patient
- Save the event data to a file
- Archive reports in a secure environment

The HeartStart data management software suite includes the following packages. Software version numbers are current as of June 2007.

HEARTSTART EVENT REVIEW¹ is an application for electronically managing the ECG case data, including shocks and, for certain models, audio, recorded by your Philips or Laerdal AED. It allows you to add case details by adding notes and completing basic data entry screens. Using Event Review, you can integrate ECGs from multiple defibrillators into one case for a complete event history. Case reports include ECG waveform, event log and case data. With Event Review, you can perform ad hoc queries of the database and e-mail cases to colleagues who are running Event Review or Event Review Pro for review. Event Review can also be used to configure the HeartStart FRx and HSI family of AEDs. Available in English, French, German, Spanish, Italian, and Japanese.

EVENT REVIEW PRO is a comprehensive application for electronically managing the ECG case data, including shocks and, for certain models, audio, recorded by your Philips and Laerdal AEDs. HeartStart Event Review Pro helps the medical director or code team leader take a big-picture view of their resuscitation program in order to evaluate and optimize resuscitation response. It lets them collect and review more comprehensive response and patient data than Event Review, including detailed BLS and ALS responder observations and interventions. You can integrate ECGs from multiple

1. Event Review, introduced in early 2003, replaced the stand-alone CodeRunner Web Express software. When Event Review was introduced, the CodeRunner Web software was renamed Event Review Pro.

defibrillators into one case for a complete event history. With Event Review Pro, you can produce case reports, 12-lead reports, Utstein reports and overall system response time summaries. With Event Review Pro, you can perform ad hoc queries of the database and e-mail cases to colleagues who are running Event Review or Event Review Pro for review. Available in English, French, German, Spanish, Italian, and Japanese.

HEARTSTART DATA MESSENGER is primarily a software application to transfer defibrillator patient data from the field to the data administrator or Medical Director who is using one of the other Event Review Suite products, such as Event Review or Event Review Pro. But it can also serve as a basic case review tool in a PAD/corporate setting. You can also print and store defibrillator cases as files (not in a database). And you can email the patient's presenting rhythm to the patient's physician as a PDF if he or she would like to see it. Please note that the ECG data is not intended for diagnostic use.

Data Messenger replaces CaseCapture and Review Express Connect. A limited, stripped down version of Data Messenger, available at no cost, replaces the older Review Express.

Event Review was tested with IR adapters from ACTISYS. An approved ACTISYS adapter is available from Philips Medical Systems.

Detailed information about the Event Review suite of data management software programs is available online at www.philips.com/eventreview.

SYSTEM REQUIREMENTS

Event Review suite operates on a computer running either the Microsoft Windows XP or Microsoft Windows 7™ operating system. Make sure that any hardware you choose is certified as Microsoft-compatible.

Philips provides only the Event Review software. The software and hardware listed in the following table are provided by the customer, unless noted. The following table provides information on software, hardware, and accessory requirements:

SOFTWARE	COMPONENT REQUIREMENTS
Operating System	<ul style="list-style-type: none"> • Microsoft Windows XP Professional SP3, or Microsoft Windows XP tablet Edition SP3 • Microsoft Windows 7 • Microsoft Windows Server 2008 R2, 2008. 2003 R2, or 2003 for a remote server running the shared database
Database	Microsoft SQL Server 2008 R2, 2008, or 2005
HARDWARE	COMPONENT REQUIREMENTS
Processor Speed	Minimum: 1 GHz Recommended: 2 GHz core duo or higher
Display Resolution	Minimum: 1024x768 Recommended: 1400x1050 or higher
Video Memory	Minimum: 64 MB Recommended: 256 MB
Memory	Minimum: 1 GB Recommended: 2 GB or higher
Disk Space	Minimum: 2 GB Recommended: 5 GB <i>NOTE: Hard-disk space requirements vary depending on usage and defibrillator type. Variables affecting space requirements include the number of cases and the amount of audio data archived.</i>
ACCESSORIES	COMPONENT REQUIREMENTS
Printer	Minimum: 1 GHz Recommended: 2 GHz core duo or higher
PDF Reader	Purpose: To view the HeartStart Event Review User Guide Recommended: Adobe Reader, latest version. <i>NOTE: For more information, go to http://get.adobe.com/reader.</i>
Backup and Restore Tool	Purpose: To prevent data loss and corruption

ACCESSORIES	COMPONENT REQUIREMENTS
Connection to a Time Server	Purpose: To synchronize your computer date and time. <i>NOTE: If you use a time server, do not alter your system clock manually.</i>
Email Application	Purpose: To activate the software by email or to send cases using email, and to configure a MAPI-compliant email client
IrDA Support	Purpose: To read information from the HSI defibrillator. <ul style="list-style-type: none"> • IrDA functionality • Infrared transceiver or infrared adapter <i>NOTE: The transceiver will appear as a small dark-red or black window on the computer and device displays.</i>

COMPARISON OF EVENT REVIEW AND EVENT REVIEW PRO

FEATURE	EVENT REVIEW	EVENT REVIEW PRO
12-Lead ECG	No	Yes
ECG Zoom	No	Yes
ECG Selections	No	Yes
Waveforms	Pads, Compression	All
Waveform Controls	No	Yes
Q-CPR Detail Report	No	Yes
Q-CPR Exclusions	No	Yes
WFDB Export	No	Yes
Shared Database	No	Yes
Vital Trends	No	Yes
Import Service	No	Yes
Research Mode	No	Yes (Not Available Commercially)
EMS Notes	Subset	Yes (EMS Edition)
Hospital Notes	No	Yes (Hospital Edition)
System Response Reports	No	Yes (EMS Edition)
Utstein Reports	No	Yes (EMS Edition)

SYSTEM ANNOTATIONS

A variety of different event annotations appear on the ECG when the Event Review software prints it out. Some, like “shock advised” and “shock delivered,” are self-explanatory and relate directly to the treatment of the patient. Others, like “monitoring,” are less obvious and relate to the internal state of the defibrillator. Annotations that can appear on the ECG printout for current software are listed and defined below. Definitions assume default device configuration that complies with the Guidelines 2005.

ANALYZING — The defibrillator is in analyze mode; it has started to actively analyze the patient’s ECG and has given the voice prompts to instruct the user not to touch the patient. The internal capacitor is partially charged in this state, and the defibrillator will either (a) advise a shock and fully charge the capacitor or (b) give a no-shock advised prompt, disarm, and go into monitor mode.

ARMED — At this point, the defibrillator is fully charged, and the user can deliver a shock to the patient by pressing the shock button.

ARTIFACT — This indicates that the defibrillator has detected artifact corruption of the ECG within the previous five seconds.

CONTINUED USE — The defibrillator has been turned back on within five minutes of the previous use. It is assumed that the defibrillator is being used on the same patient, so this ECG is appended to the previous ECG.

MONITORING — The defibrillator has transitioned from analyze mode to monitor mode. While monitoring, the defibrillator is still reviewing the patient’s ECG, but has informed the user that it is safe to touch the patient. If it detects a potentially shockable rhythm while in monitor mode, the defibrillator will go back to analyze mode and instruct the user to not touch the patient. The internal capacitor has no charge on it in monitor mode.

NO SHOCK ADVISED — The defibrillator has determined that the patient’s rhythm is not considered shockable.

PADS MARGINAL — The defibrillator has detected pads at this point, but the impedance measured is too high to obtain a good ECG reading or to deliver an effective shock if required. The defibrillator will give voice prompts (e.g., “press pads firmly”) to alert the user that the defibrillation pads are not making good contact.

PADS OFF — The measured impedance has become too high and indicates that the defibrillation pads are no longer connected between the defibrillator and the patient’s chest.

PADS ON — The measured impedance is low enough to indicate that the defibrillation pads are making good contact to the patient's chest, and the defibrillator can proceed to analyze the ECG.

RESUME ANALYSIS — The defibrillator has either detected a potentially shockable rhythm while in monitor mode or has transitioned back into analyze mode after completing a pause period.

SHOCK ABORT — The shock was aborted either because the defibrillator detected a change to a non-shockable rhythm or the user failed to press the Shock button.

SHOCK ADVISED — The defibrillator has determined that the patient's rhythm is considered shockable and begins to fully charge the internal capacitor so that a shock may be delivered.

SHOCK # DELIVERED — Indicates the point at which a given shock is delivered to the patient. (“#” will be the actual number of that shock.)

SHOCK INITIATED — Indicates the point at which the shock button was pressed by the user.

START OF ECG — This marks the point on the printout when the ECG recording begins in HSI internal memory. The defibrillator begins ECG recording when the pads are connected to the patient's chest.

START PAUSE — This indicates the beginning of a protocol pause or an NSA pause. During a protocol pause, the HSI does not monitor the patient's rhythm so that CPR can be provided if needed. During a SMART NSA pause, the defibrillator conducts background monitoring and, if a potentially shockable rhythm is detected and no CPR is detected, returns to rhythm analysis.

TECHNICAL SUPPORT FOR DATA MANAGEMENT SOFTWARE

Telephone support for the HeartStart Event Review software suite in North America is provided by the Philips Customer Care Solutions Center in Alpharetta, Georgia, USA. For telephone assistance outside the United States, please call your local sales representative or Local Response Center.

For English-only email support, internationally and in North America, please email Philips Healthcare HeartStart Event Review support at eventreview@philips.com.

For on-line support, internationally and in North America, please contact Philips Healthcare data management support at www.philips.com/DataManagementSupport.

CONFIGURATION SOFTWARE

The HeartStart HSI Defibrillators come with a factory default configuration designed to meet the needs of most users. This configuration can only be changed by using special HeartStart software available from Philips. The setup of the HSI can be modified using HeartStart Configure version 1.0 or higher.

HEARTSTART CONFIGURE software is for use by trained personnel. The software enables you to review and change the configuration of HeartStart HSI defibrillators. With HeartStart Configure software installed on a PC, you can retrieve the current configuration from the defibrillator, reset the configuration to default values, or revise individual settings according to your Medical Director's directive, and transmit them to the defibrillator.

To more efficiently manage configuration for your defibrillator program, HeartStart Configure also lets you save HSI settings to a file on your PC. This lets you transmit the same configuration to all your AEDs as well as maintain a record of allowable settings.

NOTE: Federal Law (USA) restricts this product to sale by or on the order of a physician. Your defibrillator's configuration determines its behavior during an emergency. Changes must be made only by authorized personnel under the oversight of a medical professional. Software should not be shared and handheld security measures such as password protection should be taken.

HeartStart AEDs have been environmentally tested to demonstrate conformance to numerous standards. In addition, stress testing and life testing has been conducted to provide a design that is rugged and reliable and results in a product that performs well in the many new environments that an AED may be used in. To date, HeartStart AEDs have accumulated over a billion hours of powered service.

Except as otherwise noted, the information below applies to the Philips HeartStart OnSite, the Laerdal HeartStart HSI, and the Philips HeartStart Home Defibrillators, models M5066A, M5067A, and M5068A, respectively. These products are classified as Class IIb, Rule 9 of Annex IX of the MDD. All these devices meet the provisions of the council Directive 93/42/EEC for Medical Devices. All supporting documentation is retained under the premises of the manufacturer, Philips Medical Systems, Heartstream.

STANDARDS APPLIED

- AAMI DF80:1993
- AAMI ES1:1993
- AS/NZ 3200.1.0
- BS EN60086-4
- CAN/CSA-C22.2 No 601.1-M90 and Supplement 1:1994
- CISPR 11:1997 / EN 55011:1998
- EN 1789:1999
- EN 60529:1992
- IEC 61000-4-2:2001 / EN 61000-4-2:1995 and A1
- IEC 61000-4-3:2001 / EN 61000-4-3:1996
- IEC 601-2-4:1983
- IEC 60601-1-1:1992-06
- IEC 60601-1-2:2001 / EN 60601-2:1993
- IEC 60601-2-4:1983 / EN 60068
- IEC 825:1993

In addition to the standard testing done on medical devices, HeartStart AEDs have been tested in numerous field environments where devices have been deployed. These field environments may subject the devices to environmental conditions well past the specifications listed below and may involve much higher electric or magnetic field strengths. When there is concern about using an AED in extreme conditions, it is possible to test on site to insure that the performance of the HeartStart AED will not be adversely affected by the environment or will not affect the performance of surrounding equipment if used in that environment.

HSI AED SPECIFICATIONS

PHYSICAL

CATEGORY	SPECIFICATIONS
size	2.80" H x 7.40" D x 8.30" W (7.1 cm H x 19cm D x 21cm W).
weight	Approximately 3.3 lbs (1.5 kg) with battery and pads cartridge installed.
pads compatibility	HeartStart Adult SMART Pads M5071A and HeartStart Infant/Child SMART Pads M5072A

ENVIRONMENTAL

CATEGORY	SPECIFICATIONS
temperature and relative humidity	Operating (battery and pads cartridge installed): 32° to 122° F (0° to 50° C); 0% to 95% RH (non-condensing). Standby (battery and pads cartridge installed): 50° to 109° F (10° to 43° C); 10% to 75% RH (non-condensing). Storage/shipping (with battery and pads case): -4° to 140° F (-20° to 60° C) for up to 2 days; 0% to 85% RH (non-condensing).
altitude	0 to 15,000 feet (0 to 4,572 m).
shock/drop abuse tolerance	Withstands 1 meter drop on any edge, corner, or face of the device onto masonry surface.
vibration	Operating: meets EN1789 random, road ambulance. Standby: meets EN1789 swept sine, road ambulance.
sealing	Drip proof per EN60529 class IPx1. Solid Objects per EN60529 class IP2x.

CONTROLS AND INDICATORS

CATEGORY	SPECIFICATIONS
controls	Green SMART Pads cartridge handle Green On/Off button Blue i-button Orange Shock button

CATEGORY	SPECIFICATIONS
indicators	<p>Ready light: green, blinks when the defibrillator is in standby mode (ready for use); solid when the defibrillator is being used.</p> <p>i-button: blue, flashes when information is available, on solid during patient care pause.</p> <p>Caution light: flashes when the defibrillator is analyzing, comes on solid when the defibrillator is ready to deliver a shock.</p> <p>Shock button: orange, flashes when the defibrillator is charged and ready to deliver a shock.</p>
audio speaker	Provides voice instructions and warning tones during normal use.
beeper	Provides chirps when troubleshooting is needed.
status indicator	Status indicator LCD displays device readiness for use.
low battery detection	Automatic during daily periodic self-testing.

DEFIBRILLATION WAVEFORM

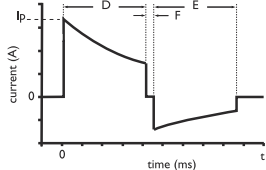
CATEGORY	SPECIFICATIONS																																																																																
waveform parameters 	<p>Biphasic truncated exponential. Waveform parameters are automatically adjusted as a function of patient defibrillation impedance. In the diagram at left, D is the duration of phase 1 and E is the duration of phase 2 of the waveform, F is the interphase delay (500 μs), and Ip is the peak current.</p> <p>The HeartStart HSI delivers shocks to load impedances from 25 to 180 ohms. The duration of each phase of the waveform is dynamically adjusted based on delivered charge, in order to compensate for patient impedance variations, as shown below:</p> <p style="text-align: center;">adult defibrillation</p> <table border="1"> <thead> <tr> <th>load resistance (Ω)</th> <th>phase 1 duration (ms)</th> <th>phase 2 duration (ms)</th> <th>peak current (A)</th> <th>delivered energy (J)</th> </tr> </thead> <tbody> <tr><td>25</td><td>2.8</td><td>2.8</td><td>55</td><td>128</td></tr> <tr><td>50</td><td>4.5</td><td>4.5</td><td>32</td><td>150</td></tr> <tr><td>75</td><td>6.3</td><td>5.0</td><td>23</td><td>155</td></tr> <tr><td>100</td><td>8.0</td><td>5.3</td><td>18</td><td>157</td></tr> <tr><td>125</td><td>9.7</td><td>6.4</td><td>14</td><td>159</td></tr> <tr><td>150</td><td>11.5</td><td>7.7</td><td>12</td><td>160</td></tr> <tr><td>175</td><td>12.0</td><td>8.0</td><td>11</td><td>158</td></tr> </tbody> </table> <p style="text-align: center;">pediatric defibrillation (using M5072A infant/child reduced-energy defibrillator pads)</p> <table border="1"> <thead> <tr> <th>load resistance (Ω)</th> <th>phase 1 duration (ms)</th> <th>phase 2 duration (ms)</th> <th>peak current (A)</th> <th>delivered energy (J)</th> </tr> </thead> <tbody> <tr><td>25</td><td>4.1</td><td>2.8</td><td>24</td><td>35</td></tr> <tr><td>50</td><td>5.1</td><td>3.4</td><td>16</td><td>46</td></tr> <tr><td>75</td><td>6.2</td><td>4.1</td><td>12</td><td>52</td></tr> <tr><td>100</td><td>7.2</td><td>4.8</td><td>10</td><td>54</td></tr> <tr><td>125</td><td>8.3</td><td>5.5</td><td>8</td><td>56</td></tr> <tr><td>150</td><td>9.0</td><td>6.0</td><td>7</td><td>57</td></tr> <tr><td>175</td><td>9.0</td><td>6.0</td><td>6</td><td>55</td></tr> </tbody> </table>	load resistance (Ω)	phase 1 duration (ms)	phase 2 duration (ms)	peak current (A)	delivered energy (J)	25	2.8	2.8	55	128	50	4.5	4.5	32	150	75	6.3	5.0	23	155	100	8.0	5.3	18	157	125	9.7	6.4	14	159	150	11.5	7.7	12	160	175	12.0	8.0	11	158	load resistance (Ω)	phase 1 duration (ms)	phase 2 duration (ms)	peak current (A)	delivered energy (J)	25	4.1	2.8	24	35	50	5.1	3.4	16	46	75	6.2	4.1	12	52	100	7.2	4.8	10	54	125	8.3	5.5	8	56	150	9.0	6.0	7	57	175	9.0	6.0	6	55
load resistance (Ω)	phase 1 duration (ms)	phase 2 duration (ms)	peak current (A)	delivered energy (J)																																																																													
25	2.8	2.8	55	128																																																																													
50	4.5	4.5	32	150																																																																													
75	6.3	5.0	23	155																																																																													
100	8.0	5.3	18	157																																																																													
125	9.7	6.4	14	159																																																																													
150	11.5	7.7	12	160																																																																													
175	12.0	8.0	11	158																																																																													
load resistance (Ω)	phase 1 duration (ms)	phase 2 duration (ms)	peak current (A)	delivered energy (J)																																																																													
25	4.1	2.8	24	35																																																																													
50	5.1	3.4	16	46																																																																													
75	6.2	4.1	12	52																																																																													
100	7.2	4.8	10	54																																																																													
125	8.3	5.5	8	56																																																																													
150	9.0	6.0	7	57																																																																													
175	9.0	6.0	6	55																																																																													

CATEGORY	SPECIFICATIONS												
energy	<p>Using HeartStart Adult SMART Pads or adult defibrillation: 150 J nominal ($\pm 15\%$) into a 50 ohm load.</p> <p>Using HeartStart Infant/Child SMART Pads: 50 J nominal ($\pm 15\%$) into a 50 ohm load. Sample pediatric energy doses:</p> <table border="1"> <thead> <tr> <th>age</th> <th>energy dose</th> </tr> </thead> <tbody> <tr> <td>newborn</td> <td>14 J/kg</td> </tr> <tr> <td>1 year</td> <td>5 J/kg</td> </tr> <tr> <td>2 - 3 years</td> <td>4 J/kg</td> </tr> <tr> <td>4 - 5 years</td> <td>3 J/kg</td> </tr> <tr> <td>6 - 8 years</td> <td>2 J/kg</td> </tr> </tbody> </table> <p>Doses indicated are based on CDC growth charts for the 50th percentile weights for boys.*</p> <p>* National Center for Health Statistics in collaboration with the National Center for Chronic Disease Prevention and Health Promotion. <i>CDC growth charts: weight-for-age percentiles, revised and corrected</i> November 28, 2000. Atlanta, GA: Centers for Disease Control and Prevention © 2000.</p>	age	energy dose	newborn	14 J/kg	1 year	5 J/kg	2 - 3 years	4 J/kg	4 - 5 years	3 J/kg	6 - 8 years	2 J/kg
age	energy dose												
newborn	14 J/kg												
1 year	5 J/kg												
2 - 3 years	4 J/kg												
4 - 5 years	3 J/kg												
6 - 8 years	2 J/kg												
charge control	Controlled by Patient Analysis System for automated operation.												
shock cycle timing	<p>Patient care pause-to-shock: Quick Shock. 8 seconds, typical.</p> <p>Shock-to-shock: < 20 seconds typical, including analysis.</p> <p>After 15 shocks, the HSI takes <30 seconds from analyzing to ready-to-shock.</p> <p>After 200 shocks, the HSI takes <40 seconds from initial power-on to ready-to-shock.</p>												
“charge complete” indicator	Shock button flashes, audio tone sounds; device is able to deliver a shock as soon as a shock is advised.												
disarm	<p>Once charged, the HeartStart HSI will disarm if:</p> <ul style="list-style-type: none"> patient’s heart rhythm changes to non-shockable rhythm, a shock is not delivered within 30 seconds after the HSI is armed, the On/Off button is pressed for one second to turn off the HSI, the Infant/Child Key is inserted or removed, the battery has been removed or is completely depleted, or the impedance between pads is out of range. 												
adult shock delivery vector	Via HeartStart Adult SMART Pads placed in the anterior-anterior (Lead II) position.												
infant/child shock delivery vector	Via HeartStart Infant/Child SMART Pads typically placed in the anterior-posterior position.												

ECG ANALYSIS SYSTEM

CATEGORY	SPECIFICATIONS
function	Evaluates impedance of adhesive pads for proper contact with patient skin, and evaluates the ECG rhythm and signal quality to determine if a shock is appropriate.
shockable rhythms	Ventricular fibrillation (VF) and some ventricular tachycardias, including ventricular flutter and polymorphic ventricular tachycardia (VT). The HeartStart HSI Defibrillator uses multiple parameters to determine if a rhythm is shockable. <i>NOTE: Some very low-amplitude or low-frequency rhythms may not be interpreted as shockable VF rhythms. Also, for safety reasons, some VT rhythms often associated with circulation may not be interpreted as shockable rhythms.</i>
non-shockable rhythms	On detection of any non-shockable rhythm, prompts user to perform CPR if needed.
pacemaker detection	Pacemaker artifact is removed from the signal for rhythm analysis.
artifact detection	If electrical “noise” (artifact) is detected that interferes with accurate rhythm analysis, analysis will be delayed until the ECG signal is clean.
analysis protocol	Depending on results of analysis, either prepares for shock delivery or provides a pause.

ELECTROMAGNETIC CONFORMITY

Guidance and manufacturer’s declaration: The HeartStart HSI is intended for use in the electromagnetic environment specified in the tables below. The customer or user of the HeartStart HSI should assure that it is used in such an environment.

ELECTROMAGNETIC EMISSIONS

EMISSIONS TEST	COMPLIANCE	ELECTROMAGNETIC ENVIRONMENT – GUIDANCE
RF CISPR 11	Group 1 Class B	The HSI uses RF energy only for its internal function. Therefore, its RF emissions are very low and are not likely to cause any interference in nearby electronic equipment. The HSI is suitable for use in all establishments, including domestic establishments and those directly connected to the public low-voltage power supply network that supplies buildings used for domestic purposes.

ELECTROMAGNETIC IMMUNITY

IMMUNITY TEST	IEC 60601 TEST LEVEL	COMPLIANCE LEVEL	ELECTROMAGNETIC ENVIRONMENT - GUIDANCE
electrostatic discharge (ESD) IEC 61000-4-2	± 6 kV contact ± 8 kV air	± 6 kV contact ± 8 kV air	There are no special requirements with respect to electrostatic discharge. ^a
power frequency (50/60 Hz) magnetic field IEC 61000-4-8	3 A/m	3 A/m	Power frequency magnetic fields should be at levels characteristic of a typical location in a typical commercial/hospital environment. There are no special requirements for non-commercial/non-hospital environments.
radiated RF IEC 61000-4-3	10 V/m 80 MHz to 2.5 GHz	20 V/m	Portable and mobile RF communications equipment should be used no closer to any part of the HeartStart HSI, including cables, than is absolutely necessary. ^{b,c} The recommended separation distances for various transmitters and the AED are shown in the following table. Interference may occur in the vicinity of equipment marked with the following symbol: 

NOTE 1. At 80 MHz and 800 MHz, the higher frequency range applies.

NOTE 2. These guidelines may not apply in all situations. Electromagnetic propagation is affected by absorption and reflection from structures, objects and people.

- a. Generally, AEDs are sometimes susceptible to interference generated by patient and/or responder motion in environments in which a high static electric field is present (e.g., low humidity, synthetic carpets, etc.). As a safety measure, Philips AEDs incorporate a patented method to sense possible corruption of the ECG signal by such interference and to respond by directing the user to stop all motion. In these cases, it is important to minimize movement in the vicinity of the patient during rhythm analysis in order to ensure that the signal being analyzed accurately reflects the patient's underlying heart rhythm.
- b. The ISM (industrial, scientific and medical) bands between 150 kHz and 80 MHz are 6,765 MHz to 6,795 MHz; 13,553 MHz to 13,567 MHz; 26,957 MHz to 27,283 MHz; and 40,66 MHz to 40,70 MHz.
- c. Field strengths from fixed transmitters, such as base stations for radio (cellular/cordless) telephones and land mobile radios, amateur radio, AM and FM radio broadcast, and TV broadcast cannot be predicted theoretically with accuracy. To assess the electromagnetic environment due to fixed RF transmitters, an electromagnetic site survey should be considered. If the measured field strength in the location in which the HeartStart HSI is used exceeds the applicable RF compliance level above, the HeartStart HSI should be observed to verify normal operation. If abnormal performance is observed, additional measures may be necessary, such as re-orienting or relocating the HeartStart.

PORTABLE AND MOBILE RF EQUIPMENT

The HeartStart HSI Defibrillator is intended for use in an electromagnetic environment in which radiated RF disturbances are controlled. The customer or the user of the HSI can help prevent electromagnetic interference by maintaining a minimum distance between portable and mobile RF communications equipment (transmitters) and the HSI as recommended below, according to the maximum output power of the communications equipment.

RATED MAXIMUM OUTPUT POWER OF TRANSMITTER (W)	SEPARATION DISTANCE ACCORDING TO FREQUENCY OF TRANSMITTER (M)	
	80 MHZ TO 800 MHZ $D = 0.6\sqrt{P}$	800 MHZ TO 2.5 GHZ $D = 1.15\sqrt{P}$
0.01	0.06	0.115
0.1	0.19	0.36
1	0.6	1.15
10	1.9	3.64
100	6.0	11.5

For transmitters rated at a maximum output power not listed above, the recommended separation distance *d* in metres (m) can be determined using the equation applicable to the frequency of the transmitter, where *P* is the maximum output power rating of the transmitter in watts (W) according to the transmitter manufacturer.

NOTE 1. At 80 MHz and 800 MHz, the separation distance for the higher frequency range applies.

NOTE 2. The ISM (industrial, scientific and medical) bands between 150 kHz and 80 MHz are 6,765 MHz to 6,795 MHz; 13,553 MHz to 13, 567 MHz; 26,957 MHz to 27,283 MHz; and 40,66 MHz to 40,70 MHz.

NOTE 3. An additional factor of 10/3 is used in calculating the recommended separation distance for transmitters in the ISM frequency bands between 150 kHz and 80 MHz and in the frequency range 80 MHz to 2.5 GHz to decrease the likelihood that mobile/portable communications equipment could cause interference if it is inadvertently brought into patient areas.

NOTE 4. These guidelines may not apply in all situations. Electromagnetic propagation is affected by absorption and reflection from structures, objects and people.

NOTE 5. Transmitters/antenna of this power-level are most likely mounted on an emergency vehicle chassis. The distances cited here are for open field. For an external antenna, the separation distance is most likely shorter.

ACCESSORIES SPECIFICATIONS

M5070A BATTERY

CATEGORY	SPECIFICATIONS
battery type	9 VDC, 4.2 Ah, lithium manganese dioxide. Disposable, long-life primary cell.
capacity	When new, a minimum of 200 shocks or 4 hours of operating time at 77° F (25° C). (IEC 60601-2-4 2002)
shelf life (prior to insertion)	A minimum of 5 years from date of manufacture when stored and maintained according to directions provided in the <i>Owner's Manual</i> .
standby life (after insertion)	Typically, 4 years when stored and maintained according to directions provided in the <i>Owner's Manual</i> .
training life	Supports 10 hours of use in training mode.
battery type	9 VDC, 4.2 Ah, lithium manganese dioxide. Disposable, long-life primary cell.

HEARTSTART ADULT SMART PADS M5071A AND INFANT/CHILD SMART PADS M5072A

CATEGORY	SPECIFICATIONS
adult pads	Disposable, adhesive defibrillation pads with a nominal active surface area of 85 cm ² each, provided in a snap-in cartridge with an integrated 54" (137.1 cm), typical, cable.
infant/child pads	Disposable, adhesive defibrillation pads with a nominal active surface area of 85 cm ² each, provided in a snap-in cartridge with an integrated 40 inch (101.6 cm), typical, cable. Cartridge incorporates teddy bear icon on cover of seal for ready identification.
defibrillation pad requirements	Use only HeartStart Adult SMART Pads M5071A or Infant/Child SMART Pads M5072A with the HeartStart HSI Defibrillators.

ENVIRONMENTAL CONSIDERATIONS

By complying with your national or local regulations regarding disposal of electric, electronic, and battery waste, you can make a positive contribution to our shared environment.

PRODUCT	INFORMATION
defibrillator	The defibrillator contains electronic components. Do not dispose of it as unsorted municipal waste. Collect such electronic waste separately and dispose of it at an appropriate recycling facility according to your country's or local regulations.
battery	The battery cells contain chemicals. The chemistry used in each battery is identified by a symbol on the label; symbols are defined in the defibrillator Owner's Manual. Recycle the battery at an appropriate recycling facility.
pads	The used pads may be contaminated with body tissue, fluid, or blood. Dispose of them as infectious waste. Recycle the case at an appropriate recycling facility.

B TROUBLESHOOTING INFORMATION

ROUTINE TROUBLESHOOTING FOR THE HEARTSTART HSI DEFIBRILLATOR

Ready Light Troubleshooting Tips

The HeartStart's green Ready light is your guide to knowing if the defibrillator is ready for use.

- If the Ready light is blinking: The HeartStart has passed the battery insertion self-test and the last periodic self-test and is therefore ready for use.
- If the Ready light is solid: The HeartStart is in use or running a self-test.

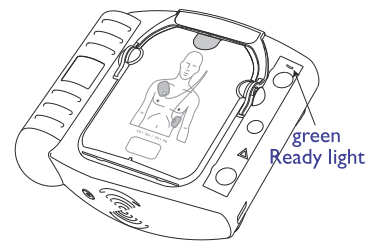

- If the Ready light is off, the HeartStart is emitting a series of single chirps, and the i-button is flashing: A self-test error has occurred, there is a problem with the pads, or the battery power is low. Press the i-button for instructions.

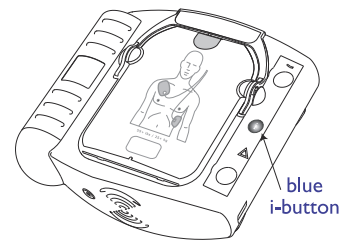



- If the Ready light is off, and the HeartStart is emitting a series of triple chirps, please call Philips for technical support. See “Troubleshooting a Chirping HeartStart,” below, for more information.
- If the Ready light is off but the HSI is not chirping and the i-button is not flashing: there is no battery inserted, the battery is depleted, or the defibrillator needs repair. Insert/replace battery and run the self-test. As long as the HSI passes the self-test, you can be assured it is ready for use.

Troubleshooting a Chirping HeartStart

Your Philips AED tests itself at regular intervals to ensure it is ready for use. If your AED emits a pattern of **single chirps** (♪ ... ♪ ... ♪ ...), please press the flashing blue i-button for information. The defibrillator will provide voice prompts that identify the problem and provide troubleshooting instructions. See the table, below, for possible causes and recommended actions for single chirps.

POSSIBLE CAUSE	RECOMMENDATION ACTION
Low battery condition due to clinical use, BITs (Battery Insertion Self-Tests), training, or premature depletion due to an internal fault within the battery or AED.	Replace depleted battery with a new one and complete the battery insertion test (BIT). <i>Note: At least 9 shocks and 15 minutes of use remain when a low battery condition is first detected.</i>
Pads have dried out because the seal was broken, the gel is defective, or the pads are past their expiration date.	Press the flashing blue i-button to confirm the condition by listening for the voice prompt, "Pads not usable, Replace pads." Replace the pads set.
Shock button was not verified during last BIT.	Remove and reinsert the battery to run BIT. Press the shock button when instructed.
Pads cartridge cover may not be installed, or the magnet in the pads set may have fallen from the back of green pull handle.	Make sure the pads cartridge is properly installed with the hard plastic cover in place. Verify that magnet isn't missing from the back of green pull handle. Replace pads cartridge if required.
Pads cartridge is not installed.	Make sure the pads cartridge is installed.
Training pads have been left installed in the defibrillator.	Remove the training pads cartridge and replace it with a clinical pads cartridge.
Device stored outside recommended temperature range of 50°F (10°C) to 109°F (43°C).	Return the device to an environment within the recommended temperature range. Remove and reinsert the battery to run a BIT.
Error detected during self-test. Marginal calibration during a self-test resulted in a warning.	Remove and reinsert battery to perform a BIT and test the device. If the defibrillator does not stop chirping, replace the battery with a new battery, or one that is known to be functional. If the device continues to chirp, remove it from service and contact your local Philips representative.
The defibrillator has been physically damaged.	Remove the defibrillator from service and contact your local Philips representative.

A **triple-chirp** alert (... ... ...), could mean that a potentially serious problem was detected during self-test that could prevent your AED from delivering therapy in an emergency. If you ever hear your AED emit a series of triple chirps:

- in stand-by mode — please call Philips immediately for technical support at the regional number listed on the back cover of this manual.
- in an emergency rescue — press the flashing blue i-button and follow the voice prompts. Removing and reinserting the battery can clear some errors and equip the device to deliver therapy in a rescue. The battery removal and reinsertion procedure should only be done in an emergency situation. Once the emergency is over, please call Philips immediately for technical support.

WARNING: Removing and reinserting the battery one or more times when an AED emits a series of triple chirps may reset the device and cause it to report it is ready for use, though it may be unable to deliver therapy during a rescue. Removing and reinserting the battery when your AED is emitting a pattern of triple chirps should only be done during an emergency. *If your device is emitting a series of triple chirps in stand-by mode, or after an emergency, please remove the AED from service and contact Philips immediately.*

TROUBLESHOOTING STEPS

If the blue i-button is flashing, press it for less than two (2) seconds, for voice prompts identifying the problem and how to fix it.

Perform a battery insertion test: remove the battery for at least five seconds, then reinstall it to automatically run a comprehensive self-test of the defibrillator. The Battery Insertion Test (BIT) is the main troubleshooting tool used with HeartStart AEDs. If the device passes the BIT and the green LED Ready light is blinking, the device is within its specifications and is ready for use.

The BIT for the HSI AED consists of two parts; the first runs automatically and the second involves user interaction. During the automatic part of the test the internal circuits are tested and the lights are turned on and off. The interactive portion of the self-test is intended to test features that cannot be tested automatically. During this portion of the test the HSI will say “shock button test” and then instruct you to push the Shock button. It will then say “On/Off button test” and instruct you to push the On/Off button. Push the buttons when instructed.

If the HSI passes the self-test, when the test is over, the HSI will report the results, then turn off and go to standby mode. The blinking green Ready light shows the defibrillator is ready for use.

If the test fails, press the blue i-button and follow the voice instructions as noted above. If the defibrillator continues to instruct you to remove and reinsert the battery, do not use the defibrillator. Contact Philips Medical Systems for technical support.

VERIFICATION OF ENERGY DELIVERY

The HSI defibrillator does not require manual verification of energy delivery, because monthly automatic self-tests verify the waveform delivery system. However, a qualified technical professional can test AED energy delivery, using the following instructions.

Test Equipment Required

- Defibrillator Analyzer, Dynatech Nevada, Impulse 3000 with any Software Revision except 1.10 and an appropriate adapter cable.*
OR
- Defibrillator Analyzer, Dynatech Nevada, Impulse 4000 with any Software Revision and an appropriate adapter cable.*
OR
- Defibrillator Analyzer, Biotek, QED6. A cable can be fabricated from the appropriate HeartStart AED pads or cartridge and two banana plugs.

Procedure with Impulse 3000

1. Connect the AED to the Impulse 3000 using the adapter cable.
2. Set up the Impulse 3000:
 - a. Set RANGE to Hi
 - b. Set POWER to On
 - c. Press ENERGY (F1)
 - d. Press VFIB (F3)
5. Press the AED On/Off button.
6. Wait for the AED to recommend a shock and when prompted, press the orange button.
7. Verify that the Impulse 3000 indicates 130-170 Joules.
8. Press the AED On/Off button and disconnect adapter cable

Procedure with Impulse 4000

1. Connect the AED to the Impulse 4000 using the adapter cable.
2. Set up the Impulse 4000:
 - a. Set POWER to On
 - b. Press DEFIB (F1)
 - c. Press NO (F1)
 - d. Press ENERGY (F1)
 - e. Press HIGH (F2)
 - f. Press VFIB (F1)
3. Press the AED On/Off button.
4. Wait for the AED to recommend a shock and when prompted, press the orange button.
5. Verify that the Impulse 4000 indicates 130-170 Joules.
6. Press the AED On/Off button and disconnect adapter cable.

* The HSI series of defibrillators do not currently have any adapter cables. A cable can be fabricated using the appropriate cartridge and two banana plugs.

Procedure with Biotek QED6

1. Connect the AED to the QED6 with the fabricated cable.
2. Setup the QED6 to measure the hi energy range, set the rhythm to VFIB.
3. Press the AED On/Off button.
4. Wait for the AED to recommend a shock and when prompted, press the orange button.
5. Verify that the QED6 indicates 130-170 Joules.
6. Press the AED On/Off button and disconnect adapter cable.

Important Notes

- If energy output is tested using any equipment other than described above, subsequent damage to the AED may occur and will invalidate product warranty.
- For questions or additional support regarding Philips AEDs, please contact your local technical support team, visit www.philips.com/AEDsupport, or email AEDSupport@philips.com. If you are a customer living in North America, please call 1-800-263-3342 for technical support.

C PADS AND BATTERY

The supplemental information in this appendix is drawn from Application and Technical Notes relating to the HSI defibrillators.

DEFIBRILLATOR PADS FOR THE HEARTSTART HSI AED

Each HSI AED is shipped with one Adult SMART Pads Cartridge M5071A, containing one set of adhesive defibrillation pads. This cartridge is designed to be installed in the HSI.

To install the pads cartridge, open the SMART Pads Cartridge package and take out the Pads Cartridge. *Do not open the pads cartridge until you need to use the pads in an emergency.* Insert the cartridge into the cartridge well on the front of the defibrillator. It should click into place when properly seated. The green PULL handle should be all the way down.

These pads have an expiration date of two years from the date of manufacture and they should be checked and replaced as needed. These pads are labeled with instructions for lay rescuers, which makes the AED easier to use by people who are not highly trained medical personnel.

The HSI AED uses special a Infant/Child SMART Pads Cartridge (M3872A) for treating children under 55 pounds (25 kg) or less than 8 years old. If you may need to defibrillate an infant or a child in this age/weight range, it is recommended that you order the Infant/Child Pads Cartridge, available separately. To replace an Adult SMART Pads Cartridge with an Infant/Child SMART Pads Cartridge, first locate the latch at the top edge of the defibrillator, and slide it to the side. The pads cartridge will be released. Lift out the Adult Pads Cartridge and install the Infant/Child Pads Cartridge as described above.

With the Infant/Child SMART Pads Cartridge installed, the HSI automatically reduces the defibrillation energy to 50 joules and, if optional CPR Coaching is selected, provides coaching appropriate for infants and children. See Chapter 5 for a discussion of pediatric defibrillation with the HSI AED.

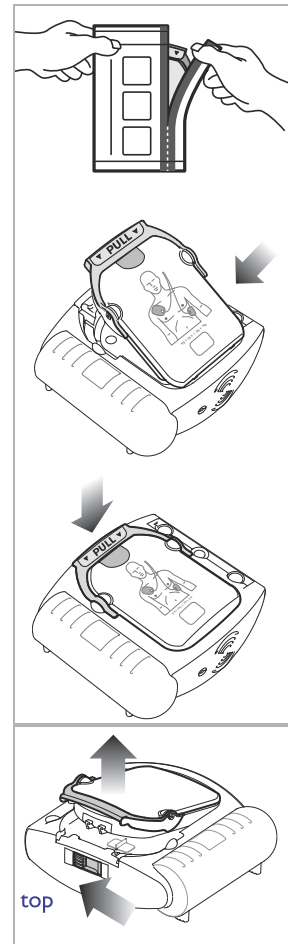

DEFIBRILLATOR PADS PLACEMENT WITH HSI AED

Proper pads placement for adult defibrillation with the HeartStart HSI defibrillator is specified with icons on the HSI front panel, on the pads themselves, and with a diagram in the *Owner's Manual*. The diagrams on the back of each pad indicate a specific location for the pad.

The Infant/Child SMART Pads Cartridge has illustrations on the pads for proper pads placement for infants or children under 55 pounds or 8 years old.

Where to place pads on adults and children over 55 pounds or 8 years old (anterior-anterior).

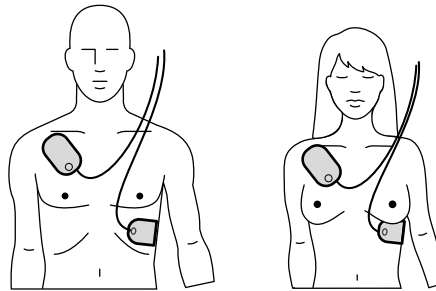

Where to place pads on infants or children under 55 pounds or 8 years old (anterior-posterior).

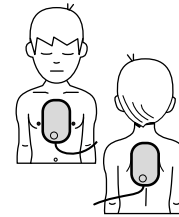

Use studies with the first Philips AED, the ForeRunner, demonstrated that users consistently took less time to apply the pads when the pads were labeled with a specific location. With this in mind, the pads themselves are labeled to show that one should be applied below the right clavicle and the other should be applied below the patient's left breast and in line with the axilla. While unpublished animal studies showed no difference in defibrillation efficacy if the pads are reversed, human factors studies showed that the unit is much easier to use if specific locations are shown for each pad.

Polarity is also specified on the pads in order to normalize the ECG recording in the HSI internal memory. If the pads are reversed, the QRS complex will be inverted when the ECG data is downloaded onto a computer running HeartStart Event Review data management software. While this may be inconvenient for viewing the ECG, it does not reduce the performance of the AED's algorithm or the efficacy of the delivered energy in any way.

The HeartStart HSI is intended for use by people with minimal training and are therefore designed to be as easy to use as possible. Labeling the pads with specific locations was just one of many design decisions made to reduce the variables present in using the device. We believe the pad labeling reassures the user during an episode and speeds up pad application, which allows them to deliver the first shock as quickly as possible when needed.

BATTERIES FOR THE HSI AED

There are several different lithium battery chemistries, each with its own set of characteristics that determine their suitability for different environments.

The standard non-rechargeable battery used in the HSI AED contain consumer grade lithium manganese dioxide (LiMnO_2) cells. The M5070A battery used by the HSI AED contains nine “2/3A” size standard camera batteries built into a custom battery pack. These same battery cells can be purchased individually at local camera stores or drugstores for use in consumer electronic devices. These batteries are designed specifically for high-volume consumer applications, where safety is of the utmost importance.

The batteries chosen for HeartStart AEDs meet Philips's high standard of quality and have been proven to be reliable and safe over many years of operation. These battery cells are recognized under the Component Program of Underwriters Laboratories, Inc. (UL) and have been extensively tested by exposing them to abusive environmental, mechanical, and electrical conditions. Additionally, a third-party testing laboratory has confirmed that the battery cells used in HeartStart AED battery packs satisfy international standards for safety.

The HeartStart M5070A battery is not rechargeable. Do not try to recharge, open, crush, or burn the battery, or it may explode or catch fire.

Differences in Battery Chemistries Utilized by AEDs

Lithium manganese dioxide (LiMnO_2) and lithium sulfur dioxide (LiSO_2) are two lithium chemistries currently used in non-rechargeable AED batteries. After evaluating both chemistries, Philips determined that LiSO_2 is unsuitable for its automated external defibrillator application. LiSO_2 batteries contain pressurized sulfur dioxide gas, which can present a serious health hazard if released into an enclosed area such as a car, a mine, or an aircraft. The evaluation also showed performance and stability problems associated with LiSO_2 batteries when the cells are periodically discharged over a prolonged period of time, such as what happens when daily self-tests are performed.

Millions of consumer-grade lithium manganese dioxide (LiMnO_2) battery cells are safely used in common consumer applications including cameras, portable electronic devices, and even wristwatches. Consumer-grade LiMnO_2 technology was chosen for the HeartStart AEDs, because it is safe to use in an AED application. The consumer-grade LiMnO_2 cells used in the HeartStart AEDs' battery packs are small, low-pressure cells that have built-in safety devices called PTCs that prevent excessive current draw above a certain temperature; the result is a safer cell design that is appropriate for use by the general public.

Disposable versus Rechargeable Batteries

Rechargeable batteries have historically been a major source of failures in AEDs, particularly as a result of poor battery maintenance practices.¹ The use of non-rechargeable batteries eliminates the need for a controlled battery maintenance process and the personnel needed to implement it. The consumer grade non-rechargeable LiMnO₂ batteries were chosen because they provide the best balance of safety, reliability and performance and meet the requirement of a low level of maintenance.

Since automated external defibrillators are typically used infrequently, they need to be as maintenance free as possible. HeartStart AEDs are designed to monitor the battery and prompt the user by way of the status indicator and audio signal if it needs to be replaced.

While LiSO₂ batteries must be manually disabled prior to disposal, HeartStart LiMnO₂ batteries meet the U.S. EPA's Toxicity Characteristic Leaching Procedure and therefore may be disposed of with normal waste without a complicated recycling process. However, out of environmental considerations, Philips recommends that all batteries be recycled at an appropriate recycling center.

Battery Usage

The M5070A battery is designed to provide a minimum of 200 shocks or 4 hours of operating life, or to last 4 years, typical, in standby mode.

There are other activities that use small amounts of energy in the battery, and if these activities are performed frequently, they can lead to a reduction in the performance life of the battery. A summary of these activities is outlined below:

Training

Any use of the HSI AED for training will directly reduce the amount of energy left in the battery to power the unit and will result in a reduction of the battery life. It is recommended that the HeartStart Trainer M4085A be used for training. It is powered by four standard AA alkaline batteries.

Battery Insertion Test (BIT)

Upon installation of the battery into the defibrillator, the unit will perform a BIT which will completely test the unit. A significant amount of energy is used during this test, including capacitor charges and discharges at 150 Joules. As a result, frequent removal and replacement of the battery will result in a noticeable reduction in battery life. Further, turning the unit off during a BIT will cause the unit to perform a monthly self-test in two hours (see below), which also expends battery power.

1. American Heart Association. *Advanced Cardiac Life Support*. September 1997, pp. 4-15.

Frequent Power-ons

During the first few seconds after turning the defibrillator on, several tests are performed to ensure the AED is ready to perform properly. As a result, frequent power-ons will significantly affect battery life. Turning the unit on periodically in an effort to ensure that the defibrillator is operating properly is unnecessary as the defibrillator will test itself periodically during stand-by mode to help verify the unit is ready for operation at all times. If servicing is required, the i-button will be flashing and the HSI will emit a loud chirping sound.

Pads Cartridge Removal/Insertion

Inserting a cartridge into an HSI series defibrillator will cause the AED to perform a series of tests to help ensure that the pads are ready for use. These tests use small amounts of battery power and frequent cartridge replacement will significantly affect battery life.

Troubleshooting

Anytime that a battery is suspected of being low or having problems, the first troubleshooting step should be to perform a BIT using the suspect battery, which is initiated by removing then re-inserting the battery into the unit. If the unit passes a BIT with no indications of battery problems, the unit and battery are both ready for service. Other conditions, such as keeping the unit outside the recommended storage temperature can cause failure messages similar to a low battery message. These messages will be cleared out with a successful BIT. If the unit does not pass the BIT, the BIT should be reattempted with a known good battery in order to determine if the battery is the cause of the failed BIT. If the unit again does not pass, contact Philips Customer Service. In the United States, contact Philips Medical Systems at 1-800-263-3342 for assistance.

D USE ENVIRONMENT

DEFIBRILLATION IN THE PRESENCE OF OXYGEN

The *Owner's Manual* provided with the HSI AED contains a warning that there is a possibility of explosion if the device is used in the presence of flammable anesthetics or concentrated oxygen. This refers to situations where a fire hazard is present. In these rare situations, a patient may be in an environment where a spark could ignite any combustibles present, such as clothes or bedding.

AEDs deliver an electrical current, so there are rare instances in which a spark may be generated between the AED and the patient during a discharge. This may occur from problems such as a faulty connection or improperly applied pads. If a spark is generated in the presence of flammable gases, it could result in a fire.

While this may be a problem in a hospital environment when an oxygen tent is in use, it is safe to deploy the defibrillator when using an oxygen canister with a mask on the patient. In this situation there are not high concentrations of oxygen accumulating around the patient's chest that would pose a risk. EMS personnel and paramedics commonly administer oxygen while performing CPR and typically do not remove this equipment if the patient needs to be defibrillated. However, if practice is to remove the oxygen mask before defibrillating, care should be taken to ensure that oxygen is not flowing across the patient's chest.

DEFIBRILLATION ON A WET OR METAL SURFACE

It is safe to defibrillate a patient on either a wet or metal surface as long as the appropriate safety precautions are taken. Specifically, care should be taken to ensure that no one is touching the patient when the shock button is pressed.

The HSI defibrillator is designed to be easy to use and have calm, clear voice prompts that reinforce the proper use of the product. When the defibrillator is analyzing the ECG, it will announce "tell the user not to touch the patient." When it decides to shock and charges, it will tell the user to stay clear of the patient. It will also inform the user when it is safe to touch the patient. All these messages are intended to make the unit safer and easier to use.

Background

When a patient is externally defibrillated, the current that travels between the pads will always seek the path of least resistance. Some of this current will pass over the surface of the patient's skin, and if the patient is resting on an electrically insulating surface, all defibrillation energy is kept within the

patient. If the user does not touch the patient during the discharge, there is no danger of them receiving a shock, as there is not a current path that would cause the user to experience a shock. However, if the patient is resting on a somewhat electrically conductive material, such as a wet surface, some of this energy may pass outside the patient. It is the presence of this energy near the patient that has prompted concern of electrical shock hazards to caregivers or bystanders during delivery of defibrillation.

Historically, patients have been defibrillated without harm on both insulating and conductive surfaces. For example, dry flooring (such as wood) does not conduct stray currents, hence inducing no potential gradient around the patient. At the other extreme, patients on metal surfaces (such as the floor of a helicopter) are also defibrillated safely, as the electricity is completely conducted through the metal and away from any bystanders. According to the American Heart Association (*Guidelines 2000*), metal surfaces “pose no shock hazard to either the victim or rescuer.”

Testing

To confirm there would be no effect on the user, Philips has simulated a 150J SMART Biphasic shock to a patient on a wet concrete surface using chlorinated pool water.¹ The voltages created in the water were tested at various points away from the simulated patient to verify that no danger existed to the user. This grid below shows the leading edge peak voltage (in volts) recorded during a defibrillation shock measured at each location on the grid.

1. Vance et al. Automated External Defibrillation in a Wet Environment World Congress on Drowning 2002, Amsterdam, 26-28 June 2002, *Book of Abstracts*, p.169

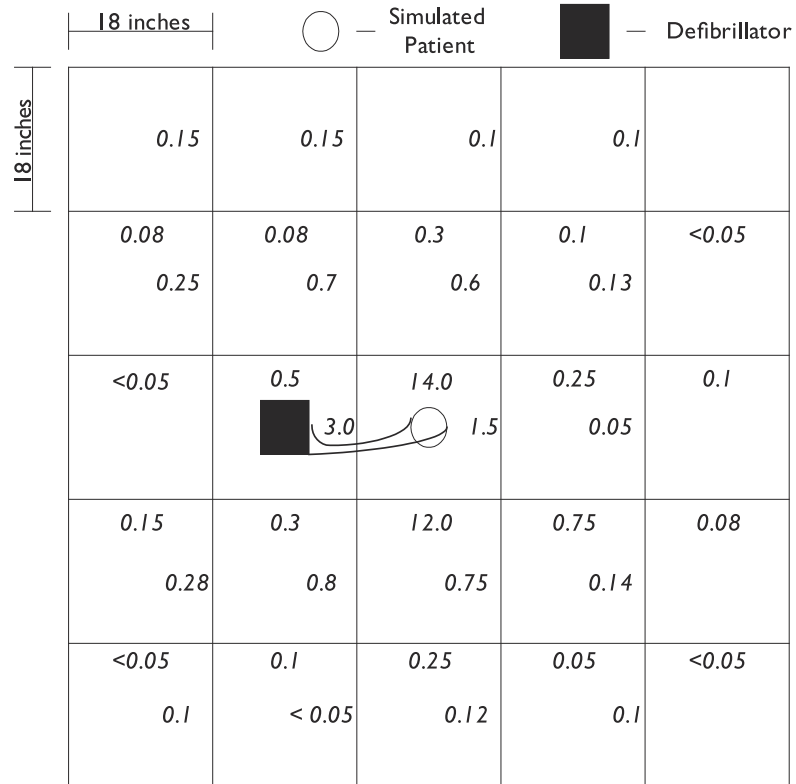

Numbers in italics are voltages at locations.

The maximum peak voltage of 14 volts occurred at a distance of approximately six inches from the simulated patient. Fourteen (14) volts are unlikely to cause any operator or bystander sensation or risk in this environment.

The voltages quickly lowered as the distance from the patient increased. At a distance of approximately 2 feet away from the patient, the maximum voltage was only 0.28 volts. At this voltage, there is virtually no operator or bystander sensation or risk in this environment.

It should be noted that the voltage recorded on the defibrillator Shock button was 0.4 V or less when placed 18 inches from the simulated patient, resulting in no sensation or risk to the user when the button is pressed.

Conclusion

Our simulation of patient defibrillation in a pool water environment demonstrated that an operator touching the defibrillator was at particularly low risk. Bystander risk in an actual defibrillation event is likely to be considerably less than the simulated bystander risk, because patient head and limbs will provide greater separation between the bystander and the defibrillation pad area.

Operation of the defibrillator in a rainy environment should present no additional risks to the operator or bystanders, since the conductivity of rainwater will be less than the pool water.

PROTECTION AGAINST WATER AND PARTICLES

The IP Code

HeartStart defibrillators use an international standard to identify the level of protection provided by the defibrillator enclosures against solid particles and water. This standard is called “IEC 529, Degrees of protection provided by enclosures (IP Code).” This standard identifies the protection with two numbers. The first number designates the level of protection against solid particles, and the second designates the level of protection against water.



Higher numbers indicate a higher level of protection. The degrees of protection are listed in the tables below:

Solid Particle Protection

first number	degree of protection	
	user protection from hazards	solid object protection
0	Non-Protected	Non-Protected
1	Protected against access to hazardous parts with the back of the hand	Protected against solid foreign objects of 50 mm diameter and greater
2	Protected against access to hazardous parts with a finger	Protected against solid foreign objects of 12.5 mm diameter and greater
3	Protected against access to hazardous parts with a tool	Protected against solid foreign objects of 2.5 mm diameter and greater
4	Protected against hazardous parts with a 1mm diameter wire	Protected against solid foreign objects of 1.0 mm and greater
5	Protected against hazardous parts with a 1mm diameter wire	Dust protected

first number	degree of protection	
	user protection from hazards	solid object protection
6	Protected against hazardous parts with a 1mm diameter wire	Dust-tight
X	Not Tested	Not Tested

Water Protection

second number	degree of protection
	protection from water
0	Non-Protected
1	Protected against vertically falling water drops
2	Protected against vertically falling water drops when enclosure is tilted 15°
3	Protected against spraying water
4	Protected against splashing water
5	Protected against water jets
6	Protected against powerful water jets
7	Protected against the effects of temporary immersion in water
8	Protected against the effects of continuous immersion in water (special conditions)
X	Not tested

Heartstart Defibrillator Testing

Each level of protection requires that the product pass a predefined test. The HSI meets the specifications for IP21. The tests performed by Philips to meet this standard are outlined below.

IP2X Testing

A 12.5 mm diameter probe was pushed into all openings of the defibrillator with a force of 30 N without passing through the openings.

The defibrillator was placed in an enclosed chamber where talcum powder was circulated for 8 hours. After 8 hours the defibrillator was removed, inspected, and tested to ensure that the powder had not accumulated enough to affect the performance of the defibrillator.

IPXI Testing

This test simulated rain falling on the device at a rate of 2.4 inches/hour. Water was dripped on the top of the defibrillator for 10 minutes. After 10 minutes the defibrillator was removed, inspected, and tested to ensure that the water had not accumulated enough to affect the performance or safety of the defibrillator.

EFFECTS OF EXTREME ENVIRONMENTS

The HeartStart HSI AED has a recommended environmental range of:

environment	range
operating temperature	32° F to 122 °F (0° C to 50° C)
operating humidity	0% to 95% RH (Relative Humidity)
standby temperature	50° F to 109° F (10° C to 43° C)
standby humidity	10% to 75% RH

These ranges are specified in the *Owner's Manual* for the defibrillator. The standby temperatures assume that a battery is installed and the unit is stored with defibrillator pads. When the defibrillator and accessories are exposed to environments outside the recommended temperature and humidity ranges, their performance can be affected. Some major effects are outlined below:

Pads

Above Standby Temperature

The gel on the defibrillator pads contains large quantities of water. Over time, this water will evaporate out of the pads through the pads packaging. At standby temperatures, this evaporation will occur over a period of years. Increases in temperature will cause the water to evaporate faster. Storing the pads at temperatures above the suggested storage temperature may cause them to expire prematurely.

Below Standby Temperature

Although the pads contain water, they will not freeze when stored at temperatures below the recommended standby temperature. There are other components in the gel, such as salt, that prevent the water from freezing. Extremely low temperatures may affect pad adhesion and shock impedance. However, when cold pads are placed on a warm patient, they will warm up quickly and will be ready to use for therapy.

Batteries

Above Standby Temperature

All batteries self-discharge over time, and the rate of this discharge increases as the storage temperature increases. Storing the batteries (in or out of the defibrillator) above the recommended standby temperature will cause the batteries to become depleted prematurely.

Self-Test Failures

The defibrillators will not perform the daily self-tests if the temperature is below 50° F (10° C) or above 109° F (43° C) for the HSI defibrillator. This is to prevent inaccurate results as the electronic components tested perform differently at temperatures outside of the recommended standby temperature ranges. Extended storage above or below these temperatures will cause the unit to begin chirping and produce a flashing “i-button” to warn the user that the tests are not being performed and the unit may not be ready for use. A battery insertion test (initiated by removing and re-inserting the battery) will test the unit and typically clear the failure message.

SELF-TEST ABORTS DUE TO TEMPERATURE EXTREMES

Background

HeartStart AEDs employ daily self-tests to ensure that the units are always ready for use. However, the devices will not perform these tests during extreme temperature conditions. Because computer electronics perform differently at different temperatures, these self-tests are aborted above and below certain temperatures to ensure that the self-tests produce accurate results.

Technique

HeartStart Defibrillators have an electronic thermometer that measures the temperature of the defibrillator's immediate environment. If the temperature is measured below 50° F (10° C) or above 109° F (43° C) for the HSI AED, the self-test will abort. The defibrillator will then attempt to perform the test again 8 hours later (instead of the standard 24 hours), to allow for the ambient temperature to either increase or decrease. If this test is aborted again, the unit will attempt to perform the self-test once again in another 8 hours. If the defibrillator aborts the self-test three times in a row (over a 16 hour period) it will issue a warning that the unit is being stored incorrectly and is not capable of accurately performing its self-tests, and may not be ready for service.

Notification

The HSI AED announces the temperature-related aborts through a series of audible chirps and a flashing “i-button.” The notification is very similar to, and can be easily confused with, a low battery warning. Take care not to discard an otherwise good battery when this occurs.

What to Do

If this notification or any similar notification occurs, a battery insertion test (BIT), initiated by removing and re-inserting the battery, should be performed at room temperature. This will likely clear the failure and ensure that the defibrillator is ready for use. The unit will still attempt to operate in an emergency even though it has aborted the self-tests due to a temperature extreme, and it is recommended that the unit be used in such a situation. To prevent this issue from occurring again, the defibrillator should be stored within the specified standby temperatures — 50°-109° F (10°- 43° C) — as noted in the *Owner’s Manual*.

E GUIDELINES 2005/2010

PHILIPS AEDS OPTIMIZED FOR GUIDELINES 2005 ALSO SATISFY GUIDELINES 2010

The American Heart Association (AHA) Guidelines 2010 for Cardiopulmonary Resuscitation and Emergency Cardiac Care and the European Resuscitation Council (ERC) Guidelines for Resuscitation 2010 (“Guidelines 2010”) were published on October 18, 2010. The Guidelines 2010 include the following major changes for all rescuers, intended to simplify CPR for rescuers and improve bystander response:

- A change in the CPR sequence, from Airway-Breathing-Compressions (A-B-C) to Compressions-Airway-Breathing (C-A-B)
- Continued emphasis on providing high-quality chest compressions:
 - Push hard, push fast
 - Minimize interruptions
 - Allow full chest recoil
 - Avoid excessive ventilation
- Recommendation that the chest should be depressed at least 2 inches (as opposed to approximately 1½ to 2 inches, recommended in the 2005 edition of the Guidelines)
- Recommendation that chest compressions should be performed at a rate of at least 100/min (2005 recommendation was “Compress at a rate of about 100/min”)
- The creation of a simplified universal algorithm for adult CPR.

Upon analyzing the AED-related changes to the Guidelines 2010 compared to Guidelines 2005, Philips confirmed that the Guidelines 2005-optimized HeartStart devices also satisfy Guidelines 2010. Throughout the world, with two exceptions, all Philips AEDs carrying a “2005 GUIDELINES” label on the rear of the device fulfill the Guidelines 2010.

The exceptions are Japan and Sweden. In these nations, national resuscitation committees produced country-specific guidelines derived from the Guidelines 2010. The Japanese and Swedish guidelines varied sufficiently from the original that the FRx and HSI series AEDs had minor conflict in complying. Philips has since provided Guidelines 2010 updates that address those conflicts for devices configured to speak Japanese and Swedish. In addition, Guidelines 2010 updates are also available for the HSI for all localizations used in HSI AEDs that were never updated to Guidelines 2005.

The Guidelines 2010 state, “*The release of new recommendations is not meant to imply that care involving the use of earlier Guidelines is either unsafe or ineffective.*” The new Guidelines do not obsolete current technologies, nor do

they negate previous Guidelines. There is no ILCOR (International Liaison Committee on Resuscitation) mandate that requires replacement or upgrade due to Guidelines changes. Customers who have a functioning defibrillator should always maintain the device in good working order so that it is ready for use in the event of a cardiac arrest emergency.

RECONFIGURING THE HSI TO CONFORM TO YOUR DESIRED SETTINGS

The Guidelines 2005-compliant HSI can be reconfigured from the default CPR protocol with ventilation to compressions-only CPR. Please note that the compressions-only CPR coaching cannot be configured and compressions-to-ventilation ratio cannot be changed in HSI devices observing Guidelines 2000. If your HSI was purchased prior to June 2006, or does not have “2005 GUIDELINES” on the back label, contact your local Philips representative for upgrade options if you would like your device to provide compressions-only CPR coaching or a 30:2 compressions-to-ventilation ratio.

To configure your HeartStart HSI to conform to your Medical Director’s emergency response workflow without sending the device, back to the factory, see the instructions below.

REQUIREMENTS

The HeartStart HSI defibrillator uses an infrared (IR) communications port to transfer information to and from a computer. The infrared port is located on the lower right side of the defibrillator. Reconfiguring the protocol settings in HsI AED requires the following hardware and software:

- An infrared link between the computer and defibrillator. Many computers have infrared ports. However, some of these ports do not work with the infrared port on the defibrillator. If the computer does not have an infrared port, or the port does not work with the defibrillator, you can add an infrared adapter. (It is recommended that you use the Philips Infrared data cable/adapter, (Philips part number ACT-IR, manufacturer’s part number ACT-IR4002US.)
- One of the following Philips HeartStart configuration or data management software applications: HeartStart Configure (Philips part number: 861487) or HeartStart Event Review 3.5 (no longer available for purchase).

INSTALLING AN INFRARED DEVICE

Philips HeartStart AEDs and software were tested with ACTiSYS USB adapters. For the best results, use the ACT-IR4002US, and follow the manufacturer’s instructions. The steps below include additional tips to help with installation of your infrared device.

1. Read the instructions that came with the adapter.
2. Run the setup program that came with the adapter to install the device driver.
3. Connect the infrared adapter to the computer.
4. The New Hardware Wizard will appear and guide you through the setup process.

NOTE: If Windows detects an active wireless device, it starts the Windows Wireless Link, which may display status messages during the installation process for your infrared adapter. Any status messages from Window Wireless Link will not affect the installation process and can be safely ignored.

To transfer information, the defibrillator must be in administration mode. The following section explains how to prepare the defibrillator to transfer information.

PUTTING THE DEFIBRILLATOR IN ADMINISTRATION MODE

To transfer information, the defibrillator must be in administration mode. The following section explains how to prepare the defibrillator to transfer information.

1. Make sure a battery is installed in the defibrillator.
2. Remove the pads connector. Although the defibrillator may prompt you to plug in the pads connector, do not reconnect the pads.
3. Press and hold the blue i-button on the front of the defibrillator until you hear three tones. The defibrillator sounds a tone two seconds after pressing the i-button, then sounds two additional tones two seconds later.
4. Release the blue i-button. The HeartStart will announce "Administration."
5. Briefly press and release the blue i-button one more time. The HeartStart will announce "Mode One," indicating that it is now operating in infrared communication mode.

SETTING UP THE INFRARED PORT CONNECTION

Position the defibrillator so that its IR port faces the IR port on the computer or IR adapter. Ensure that the ports are within two feet of each other, and have an unobstructed path between them. This will allow you to send and receive information between the defibrillator and the computer running one of the applications in the HeartStart configuration and data management software suite.

NOTE: The defibrillator will cancel its administration mode if it does not receive a transmission from the computer within 3 minutes of starting administration mode.

IMPORTANT: Remember to plug in the HSI pads connector when you finish transferring data, to ensure that the defibrillator is ready for use.

USING HEARTSTART CONFIGURE 3.X SOFTWARE TO RECONFIGURE THE HSI



The following section describes how to use HeartStart Configure 3.x software to reconfigure your HSI defibrillator to conform to your Medical Director's desired settings.

1. Install Configure 3.x on your computer, if you have not already done so.
 - a. Insert the CD that came with your Configure software into the computer's CD-ROM drive.
 - b. Run the HeartStart Configure Installer.
 - c. Activate the software using the serial number that came with your purchase.
 - d. Start the HeartStart Configure 3.x software.
 - e. A warning window will appear indicating that this software will change device behavior. Click **OK**.
2. Put the defibrillator in administration mode and establish a connection with your computer.
3. On the navigation pane, click **Configurations**, and then click one of the following:
 - If your HSI has "2005 GUIDELINES" on the back label, then click **Configure an HSI (Guidelines 2005/2010)**.
 - If your HSI does *not* have "2005 GUIDELINES" on the back label, then click **Configure an HSI (Guidelines 2000)**.
4. In the **File** menu, click **Retrieve**. Or, in the toolbar at the top of the Configure screen, click  **Retrieve configuration from defibrillator or its data card**.
5. In the "Welcome to the Configuration Transfer Wizard" window, click **Next**. On the "Select Defibrillator" page, click on the row with HeartStart HSI in the list, and then click **Next**. The selected AED is identified by a Serial Number as well as the interface type (infrared). The wizard displays a page indicating the status of the configuration retrieve operation.
6. The current configuration settings (retrieved from the defibrillator) will be displayed in the Configurations workspace. Click on the

parameter that you want to change, and then click the updated value or option. For example,

- if you have a 2005 Guidelines device, select **No Ventilation** for the CPR adult ventilation parameter to configure the HSI to provide compressions-only prompts.
- if you have a 2000 Guidelines device, change SHOCK SERIES to “1,” PROTOCOL PAUSE TIMER to “2 minutes,” NSA PAUSE TIMER to “2 minutes,” and CPR Prompt to “CPR I” (short prompt).

NOTE: If a field has gray, wavy lines through it, it is either not applicable and cannot be changed, or is dependent on another field, which must be modified first.

7. When you have finished making changes to the settings, open the **File** menu and click **Send**. Or, on the toolbar, click  **Send configuration to defibrillator**.
8. In the “Welcome to the Configuration Transfer Wizard” window, click **Next**. On the “Select Defibrillator” page, click on the row with HeartStart HSI in the list, and then click **Next**. The selected AED is identified by a Serial Number as well as the interface type (infrared). The wizard displays a page indicating the status of the configuration send operation.
9. To save and reuse this configuration for other HSI AEDs, open the **File** menu and click **Save**. Or, on the toolbar, click  **Save configuration to THIS COMPUTER for reuse later**.
10. When you have finished reconfiguring your HSI, exit the HeartStart Configure software.

USING EVENT REVIEW 3.5 SOFTWARE TO RECONFIGURE THE HSI

The following section describes how to use Event Review 3.5 software to configure your HeartStart HSI AED to meet AHA Guidelines.

- I. Install Event Review 3.5 on your computer, if you have not already done so.
 - a. Insert the CD that came with your Event Review software into the computer’s CD-ROM drive.
 - b. Run the HeartStart Event Review Installer.
 - c. Register the software at www.philips.com/software_registration.
 - d. Start the HeartStart Event Review 3.5 software.

2. Put the defibrillator in administration mode and establish a connection with your computer.
3. Using the Event Review software, navigate to the “Configuration Manager,” then click one of the following:
 - If your HSI has “2005 GUIDELINES” on the back label, click **HSI (2005 Guidelines)**.
 - If your HSI does not have “2005 GUIDELINES” on the back label, click **HSI (2000 Guidelines)**.
4. A warning window will appear indicating that this software will change device behavior. Click **OK**.
5. In the toolbar at the top of the Event Review screen, click **Receive** to transfer the current configuration settings from the HSI AED to the Event Review software.
6. The current configuration settings from the HSI will be displayed on the Event Review Configuration Manager screen. Use the knobs on the screen to make applicable changes to the settings. For example:,
 - if you have a 2005 Guidelines device, select **No Ventilation** for the CPR adult ventilation parameter to configure the HSI to provide compressions-only prompts.
 - if you have a 2000 Guidelines device, change SHOCK SERIES to “I,” PROTOCOL PAUSE TIMER to “2 minutes,” NSA PAUSE TIMER to “2 minutes,” and CPR Prompt to “CPR I” (short prompt).
7. When you have finished making changes to the settings, click **Send** on the toolbar at the top of the screen to send the new configuration to the HSI.
8. A warning window will appear indicating that this software will change device behavior. Click **OK**.
9. To save and reuse this configuration for other HSI AEDs, click **Save** in the toolbar at the top of the screen.
10. When you have finished reconfiguring your HSI, exit the Event Review software.

TROUBLESHOOTING

If sending or receiving the updated configuration settings is not successful, the following troubleshooting actions may correct the issue:

- Ensure that the correct current AED configuration (Guidelines 2000 or 2005/2010) has been selected.
- Make sure that the defibrillator is in administration mode ONE, and that it has not timed out and returned to standby mode.

- Vary the transfer distance. The ideal distance between the IR adapter on the computer and the IR port on the defibrillator can vary. If you get communication errors, try increasing or decreasing the distance until the devices communicate successfully.
- Verify that the IR adapter is correctly installed in the computer. In some cases, Windows will be able to identify and install the correct drivers for your IR adapter automatically. In other cases, Windows may install the wrong driver. In this event, follow instructions that came with your IR adapter to install the correct drivers. The incorrect driver may seem identical in all behavior to the correct one, except that it does not transfer data correctly.
- Make sure that your computer meets the system requirements necessary to run the adapter. For most IR adapters to work correctly with Windows XP, Service Pack 2 or greater must be installed. If required, have your IT help desk update your computer's operating system accordingly.

For questions or additional support regarding Philips AEDs, please contact your local technical support team, visit www.philips.com/AEDsupport, or email AEDSupport@philips.com. If you are a customer living in North America, please call 1-800-263-3342 for technical support.

F LITERATURE SUMMARY FOR HEARTSTART AEDS

INTRODUCTION

The following pages list references for numerous studies completed to demonstrate the validity and effectiveness of the HeartStart AED technology as well as use of HeartStart AEDs in clinical situations. A brief conclusion is listed next to the reference. There is also a citation of the actual source or abstract for additional details.

The Philips HeartStart SMART Biphasic waveform is set apart from other waveforms by the sheer volume of research data available to support it. There are currently over two dozen peer-reviewed manuscripts that have been published to support the SMART Biphasic waveform.

When reviewing studies on biphasic waveforms, it is important to understand which biphasic waveform or waveforms are being studied and in what environment. For example, the SMART Biphasic waveform uses a 100 μF capacitor in its design to store the energy that will be delivered to the patient, whereas other manufacturers may use 200 μF capacitors. The value of the capacitor makes a significant difference in the amount of energy and the waveform shape required in order to be effective. In addition, defibrillation models developed for animal studies must be proven in out-of-hospital cardiac arrest studies in order to validate the model. If the results of a defibrillation model with animals contradict the results of defibrillation studies with real people in sudden cardiac arrest, then the model is questionable and should be viewed with skepticism.

The following tables provide a glimpse into the cumulative literature on the technology used in HeartStart AEDs, presented chronologically within each category. All references are peer-reviewed manuscripts. The bulk of the literature presented deals with experimental and clinical studies of the biphasic waveform. These are followed by citations of publications on pediatric defibrillation, the respective roles of CPR and defibrillation, ease-of-use and user-interface studies, and research into the use of AEDs by first responders to treat victims of sudden cardiac arrest.

REFERENCES

Defibrillation Waveform -- Animal Studies	Excerpts/Conclusions
<p>Gliner BE, Lyster TE, Dillion SM, Bardy GH. Transthoracic defibrillation of swine with monophasic and biphasic waveforms. <i>Circulation</i> 1995 Sep 15; 92(6):1634-43.</p>	<p>“This study demonstrates the superiority of truncated biphasic waveforms over truncated monophasic waveforms for transthoracic defibrillation of swine. Biphasic waveforms should prove as advantageous at reducing voltage and energy requirements for transthoracic defibrillation as they have for internal defibrillation.”</p>
<p>Tang W, Weil MH, Sun S, Yamaguchi H, Povoas HP, Pernat AM, Bisera J. The effects of biphasic and conventional monophasic defibrillation on postresuscitation myocardial function. <i>J Am Coll Cardiol</i> 1999 Sep; 34(3):815-22.</p>	<p>“Lower-energy biphasic waveform shocks were as effective as conventional higher energy monophasic waveform shocks for restoration of spontaneous circulation after 4 and 7 min of untreated VF. Significantly better postresuscitation myocardial function was observed after biphasic waveform defibrillation.”</p>
<p>Tang W, Weil MH, Sun S. Low-energy biphasic waveform defibrillation reduces the severity of postresuscitation myocardial dysfunction. <i>Crit Care Med</i> 2000 Nov; 28(11 Suppl):N222-4.</p>	<p>“We compared the effects of low-energy biphasic waveform defibrillation with conventional monophasic waveform defibrillation after a short (4 mins), intermediate (7 mins), or prolonged (10 mins) interval of untreated ventricular fibrillation. Biphasic waveform defibrillation with a fixed energy of 150 joules proved to be as effective as conventional monophasic damped sine waveform defibrillation for restoration of spontaneous circulation, with significantly lower delivered energy. This was associated with significantly less severity of postresuscitation myocardial dysfunction. The low-energy biphasic waveform defibrillation is, therefore, likely to be the future direction of transthoracic defibrillation in settings of cardiopulmonary resuscitation.”</p>
<p>Tang W, Weil MH, Sun S, Povoas HP, Klouche K, Kamohara T, Bisera J. A comparison of biphasic and monophasic waveform defibrillation after prolonged ventricular fibrillation. <i>Chest</i> 2001 Sep; 120(3):948-54.</p>	<p>“Lower-energy biphasic waveform shocks were as effective as conventional higher-energy monophasic waveform shocks for restoration of spontaneous circulation after 10 min of untreated VF. Significantly better postresuscitation myocardial function was observed after biphasic waveform defibrillation. Administration of epinephrine after prolonged cardiac arrest decreased the total energy required for successful resuscitation.”</p>
<p>Tang W, Weil MH, Jorgenson D, Klouche K, Morgan C, Yu T, Sun S, Snyder D. Fixed-energy biphasic waveform defibrillation in a pediatric model of cardiac arrest and resuscitation. <i>Crit Care Med</i> 2002 Dec; 30(12):2736-41.</p>	<p>“An adaptation of a 150-J biphasic adult automated defibrillator in which energy-reducing electrodes delivered 50-J shocks successfully resuscitated animals ranging from 3.7 to 25 kg without compromise of postresuscitation myocardial function or survival.”</p>

Defibrillation Waveform -- Animal Studies	Excerpts/Conclusions
<p>Yoon RS, DeMonte TP, Hasanov KF, Jorgenson DB, Joy ML. Measurement of thoracic current flow in pigs for the study of defibrillation and cardioversion. <i>IEEE Trans Biomed Eng</i> 2003 Oct; 50(10):1167-73.</p>	<p>“The current applied through surface electrodes followed a complex pathway through the body that has not been seen before. The high current density and the direction of streamlines along the chest wall indicate patterns of shunting current between the electrodes. Furthermore, the total amount of current flowing along the chest wall (58%-65% of the applied current) suggests that the majority of the current will travel through the chest wall. This pattern has been suggested by other researchers as a result of the chest wall having a more conductive pathway than the transthoracic pathways through the lung ($\sigma_{\text{muscle}} = 0.3 \text{ S/m}$, $\sigma_{\text{lung}} = 0.08 \text{ S/m}$)... Furthermore, asymmetry of the tissue composition (e.g., the presence of spine and the thickness of the chest wall) will also affect the current distribution. It is important to note that the majority of the current entering the heart was seen originating from these shunting currents along the precordial chest wall...</p> <p>“Although defibrillation has been in clinical use for more than 50 years, the complete current flow distribution inside the body during a defibrillation procedure has never been directly measured... In this study, CDI [current density imaging] was used to measure current density at all points within a postmortem pig torso during an electrical current application through defibrillation electrodes. Furthermore, current flow information was visualized along the chest wall and within the chest cavity using streamline analysis. As expected, some of the highest current densities were observed in the chest wall. However, current density distribution varied significantly from one region to another, possibly reflecting underlying heterogeneous tissue conductivity and anisotropy. Moreover, the current flow analysis revealed many complex and unexpected current flow patterns that have never been observed before. This study has, for the first time, noninvasively measured the volume current measurement inside the pig torso.”</p>

Defibrillation Waveform -- Animal Studies	Excerpts/Conclusions
<p>Tang W, Weil MH, Sun S, Jorgenson D, Morgan C, Klouche K, Snyder D. The effects of biphasic waveform design on post-resuscitation myocardial function. <i>J Am Coll Cardiol</i> 2004 Apr 7;43(7):1228-35.</p>	<p>“It has been previously shown that a biphasic truncated exponential (BTE) waveform may be designed to minimize the defibrillation threshold in terms of either energy or peak current but that these two notions of optimization result in different waveform shapes. These waveform variants generally are achieved through the appropriate choice of the defibrillation capacitor (e.g., 100 μF for low-energy biphasic truncated exponential [BTEL] at 150 J vs. 200 μF for high-energy biphasic truncated exponential [BTEH] at 200 to 360 J). Low-energy biphasic truncated exponential waveforms are generally characterized by higher peak current but lower energy and average current than their BTEH counterparts. Although both waveform variants are commonly available in commercial products, the question remains as to which of these approaches might result in better outcome, as characterized by survival and post-resuscitation myocardial function. . .</p> <p>“This study confirmed the hypothesis that biphasic waveform defibrillation with a BTEL waveform at 150 J is as effective as the same waveform at 200 J for successful return of spontaneous circulation while it simultaneously minimizes post-resuscitation myocardial dysfunction. We also confirmed that BTEL waveform shocks at 150 J are as effective as BTEH shocks at 200 and 360 J for successful return of spontaneous circulation while they simultaneously minimize post-resuscitation myocardial dysfunction. We further demonstrated that these effects are attributable to specific characteristics of waveform design. In particular, higher peak current is positively associated with improved survival, whereas higher energy and higher average current are associated with increased post-resuscitation myocardial dysfunction. These observations argue for a damage mechanism related to cumulative, rather than instantaneous, electrical exposure.”</p> <p>See Selected Clinical Studies at the end of this chapter for a more detailed discussion of this publication.</p>

Defibrillation Waveform -- Animal Studies	Excerpts/Conclusions
<p>Tang W, Snyder D, Wang J, Huang L, Chang YT, Sun S, Weil MH. One-shock versus three-shock defibrillation protocol significantly improves outcome in a porcine model of prolonged ventricular fibrillation cardiac arrest. <i>Circulation</i> 2006 Jun 13; 113(23):2683-9.</p>	<p>“The observation of different survival outcome despite similar defibrillation efficacy is readily understood in the context of the overall resuscitation process. When the duration of cardiac arrest is prolonged, continuous and good-quality CPR, especially chest compressions, is an extremely important determinant of successful resuscitation. Both experimental and clinical studies have demonstrated that interruption of chest compressions for as little as 10 seconds between each interval of CPR for rhythm analysis, ventilation, or patient assessment significantly reduces the number of chest compressions delivered to a patient. This, in turn, reduces coronary perfusion pressure and myocardial blood flow, decreases successful resuscitation, and increases the severity of postresuscitation myocardial and cerebral dysfunction. This is especially important with regard to AEDs, because most currently available AEDs require significantly longer than 10 seconds for rhythm analysis and charging. CPR interruptions are prolonged even further when the conventional (and recommended) 3-shock protocol is used. It is clear that the performance of a defibrillator must be viewed in a much larger context than its efficacy at terminating VF. An optimal defibrillator must minimize interruptions of CPR for voice prompts, rhythm analysis, and capacitor charging. In addition, the electrical therapy must provide high efficacy while simultaneously minimizing postresuscitation myocardial dysfunction.” See Selected Clinical Studies at the end of this chapter for a more detailed discussion of this publication.</p>

Defibrillation Waveform -- Clinical Studies	Excerpts/Conclusions
<p>Bardy GH, Gliner BE, Kudenchuk P J, Poole JE, Dolack GL, Jones GK, Anderson J, Troutman C, Johnson G. Truncated biphasic pulses for transthoracic defibrillation. <i>Circulation</i> 1995 Mar 15; 91(6):1768-74.</p>	<p>“The results of this study suggest that biphasic truncated transthoracic shocks of low energy (115 and 130 J) are as effective as 200-J damped sine wave shocks used in standard transthoracic defibrillators. This finding may contribute significantly to the miniaturization and cost reduction of transthoracic defibrillators, which could enable the development of a new generation of AEDs appropriate for an expanded group of out-of-hospital first responders and, eventually, layperson use.” NOTE: This study of a 115J and 130J waveform contributed to the development of the 150 J, nominal, therapy that ships with Philips AEDs.</p>

Defibrillation Waveform -- Clinical Studies	Excerpts/Conclusions
<p>Bardy GH, Marchlinski FE, Sharma AD, Worley SJ, Luceri RM, Yee R, Halperin BD, Fellows CL, Ahern TS, Chilson DA, Packer DL, Wilber DJ, Mattioni TA, Reddy R, Kronmal RA, Lazzara R. Multicenter comparison of truncated biphasic shocks and standard damped sine wave monophasic shocks for transthoracic ventricular defibrillation. Transthoracic Investigators. <i>Circulation</i> 1996 Nov 15; 94(10):2507-14.</p>	<p>“We found that 130-J biphasic truncated transthoracic shocks defibrillate as well as the 200-J monophasic damped sine wave shocks that are traditionally used in standard transthoracic defibrillators and result in fewer ECG abnormalities after the shock.”</p>
<p>White RD. Early out-of-hospital experience with an impedance-compensating low-energy biphasic waveform automatic external defibrillator. <i>J Interventional Cardiac Electrophysiology</i> 1997; 1:203-208.</p>	<p>“Impedance-compensating low-energy BTE waveforms incorporated into an AED terminated VF in OHCA [out-of-hospital cardiac arrest] patients with a conversion rate exceeding that reported with traditional higher energy monophasic waveforms. VF was terminated in all patients, including those with high impedance.”</p>
<p>Reddy RK, Gleva MJ, Gliner BE, Dolack GL, Kudenchuk PJ, Poole JE, Bardy GH. Biphasic transthoracic defibrillation causes fewer ECG ST-Segment changes after shock <i>Ann Emerg Med</i> 1997; 30:127-34.</p>	<p>“Transthoracic defibrillation with biphasic waveforms results in less postshock ECG evidence of myocardial dysfunction (injury or ischemia) than standard monophasic damped sine waveforms without compromise of defibrillation efficacy.”</p>
<p>Poole JE, White RD, Kanz K-G, Hengstenberg F, Jarrard GT, Robinson JC, Santana V, McKenas DK, Rich N, Rosas S, Merritt S, Magnotto L, Gallagher JV, Gliner BE, Jorgenson DB, Morgan CB, Dillon SM, Kronmal RA, Bardy GH. Low-energy impedance-compensating biphasic waveforms terminate ventricular fibrillation at high rates in victims of out-of-hospital cardiac arrest. <i>J Cardiovasc Electrophysiol</i> 1997; 8:1373-1385.</p>	<p>“The low-energy impedance-compensating BTE waveform used in this study’s AED consistently terminated long-duration VF as encountered in out-of-hospital cardiac arrest. The observed defibrillation rate exceeds that of published studies on higher energy monophasic waveforms. Higher energy is not clinically warranted with this [biphasic truncated exponential] waveform. The efficient user interface and high defibrillation efficacy of this low-energy biphasic waveform allows the AED to have device characteristics consistent with widespread deployment and early defibrillation.”</p>
<p>Gliner BE, Jorgenson DB, Poole JE, White RD, Kanz K-G, Lyster TD, Leyde KW, Powers DJ, Morgan CB, Kronmal RA, Bardy GH. Treatment of out-of-hospital cardiac arrest with a low-energy impedance-compensating biphasic waveform automatic external defibrillator. <i>Biomedical Instrumentation & Technology</i> 1998; 32:631-644.</p>	<p>“It is concluded that low-energy impedance-compensating biphasic waveforms terminate long-duration VF at high rates in out-of-hospital cardiac arrest and provide defibrillation rates exceeding those previously achieved with high-energy shocks.”</p>
<p>Gliner BE, White RD. Electrocardiographic evaluation of defibrillation shocks delivered to out-of-hospital sudden cardiac arrest patients. <i>Resuscitation</i> 1999 Jul;41(2):133-44.</p>	<p>“At each analysis time, there were more patients in VF following high-energy monophasic shocks than following low-energy biphasic shocks.”</p>

Defibrillation Waveform -- Clinical Studies	Excerpts/Conclusions
<p>White RD and Blanton DM. Biphasic truncated exponential waveform defibrillation. <i>Prehosp Emerg Care</i> 1999 Oct-1999 Dec 31; 3(4):283-9.</p>	<p>“When defibrillation is defined as termination of ventricular fibrillation at 5 seconds postshock, whether to an organized rhythm or asystole, low-energy BTE [biphasic truncated exponential] shocks appear to be more effective than high-energy MDS [monophasic damped sine] shocks in out-of-hospital arrest. For future research, the terms associated with defibrillation should be standardized and used uniformly by all investigators. In particular, there should be an agreed-upon definition of shock efficacy.</p>
<p>Schneider T, Martens PR, Paschen H, Kuisma M, Wolcke B, Gliner BE, Russell JK, Weaver WD, Bossaert L, Chamberlain D. Multicenter, randomized, controlled trial of 150-J biphasic shocks compared with 200- to 360-J monophasic shocks in the resuscitation of out-of-hospital cardiac arrest victims. <i>Circulation</i> 2000 Oct 10; 102(15): 1780-7.</p>	<p>“In summary, the results of the present study show that an appropriately dosed low-energy impedance-compensating biphasic-waveform strategy results in superior defibrillation performance in comparison with escalating, high-energy monophasic shocks in out-of hospital cardiac arrest. Moreover, the 150-J biphasic waveform AED resulted in a higher rate of ROSC [return of spontaneous circulation] and better neurological status at the time of hospital discharge.”</p>
<p>Martens PR, Russell JK, Wolcke B, Paschen H, Kuisma M, Gliner BE, Weaver WD, Gossaert L, Chamberlain D, Schneider T. Optimal response to cardiac arrest study: defibrillation waveform effects. <i>Resuscitation</i> 2001; 49:233-243.</p>	<p>“A low-energy impedance-compensating biphasic waveform strategy results in superior defibrillation performance, in terms of first shock efficacy and defibrillation in the first set of two or three shocks, when compared to traditional escalating energy monophasic defibrillators of both MTE [monophasic truncated exponential] and MDS [monophasic damped sine] design. The biphasic devices were also quicker to first shock and to first successful shock.”</p>
<p>White RD, Hankins DG, Atkinson EJ. Patient outcomes following defibrillation with a low energy biphasic truncated exponential waveform in out-of-hospital cardiac arrest. <i>Resuscitation</i> 2001 Apr; 49(1):9-14.</p>	<p>“Low-energy (150 J) non-escalating biphasic truncated exponential waveform shocks terminate VF in out-of-hospital cardiac arrest with high efficacy; patient outcome is comparable with that observed with escalating high-energy monophasic shocks. Low-energy shocks, in addition to high efficacy, may confer the advantage of less shock-induced myocardial dysfunction, though this will be difficult to define in the clinical circumstance of long-duration VF provoked by a pre-existing diseased myocardial substrate.”</p>
<p>Hess EP and White RD. Recurrent ventricular fibrillation in out-of-hospital cardiac arrest after defibrillation by police and firefighters: implications for automated external defibrillator users. <i>Crit Care Med</i> 2004 Sep; 32(9 Suppl):S436-9.</p>	<p>“VF [ventricular fibrillation] recurrence is frequent, variable in time of onset, and unrelated to the performance of bystander CPR. The prevalence and frequency of VF recurrence were unpredictable and do not adversely affect survival. Thus, vigilance for recurrent VF is essential to ensure the survival of patients who are in the care of first responders, even after initial restoration of pulses with shocks.”</p>

Defibrillation Waveform -- Clinical Studies	Excerpts/Conclusions
White RD, Blackwell TH, Russell JK, Jorgenson DB. Body weight does not affect defibrillation, resuscitation or survival in patients with out-of-hospital cardiac arrest treated with a non-escalating biphasic waveform defibrillator. <i>Crit Care Med</i> 2004; 32(9) Supplement: S387-S392.	“Overweight patients were defibrillated by the biphasic waveform used in this study at high rates, with a fixed energy of 150 J, and without energy escalation.”
White RD, Blackwell TH, Russell JK, Snyder DE, Jorgenson DB. Transthoracic impedance does not affect defibrillation, resuscitation or survival in patients with out-of-hospital cardiac arrest treated with a non-escalating biphasic waveform defibrillator. <i>Resuscitation</i> 2005 Jan; 64(1):63-9.	“High impedance patients were defibrillated by the biphasic waveform used in this study at high rates with a fixed energy of 150 J and without energy escalation. Rapid defibrillation rather than differences in patient impedance accounts for resuscitation success.”
White RD and Russell JK. Refibrillation, resuscitation and survival in out-of-hospital sudden cardiac arrest victims treated with biphasic automated external defibrillators. <i>Resuscitation</i> 2002 Oct; 55(1):17-23.	“One hundred and sixteen of 128 shocks delivered under BLS care to 49 patients with witnessed cardiac arrests presenting with VF terminated VF. Most patients (61%) refribrillated while under BLS care, many (35%) more than once. Occurrence of and time to refribrillation were unrelated to achievement of return of spontaneous circulation (ROSC) under BLS care (BLS ROSC), to survival to hospital discharge and to neurologically intact survival.”

Related Papers and Publications	Excerpts/Conclusions
American Heart Association Task Force on Automatic External Defibrillation, Subcommittee on AED Safety and Efficacy. AHA Scientific Statement. Automatic external defibrillators for public access defibrillation: Recommendations for specifying and reporting arrhythmia analysis algorithm performance, incorporating new waveforms, and enhancing safety. <i>Circulation</i> 1997;95:1277-1281.	“These recommendations are presented to enhance the safety and efficacy of AEDs intended for public access. The task force recommends that manufacturers present developmental and validation data on their own devices, emphasizing high sensitivity for shockable rhythms and high specificity for nonshockable rhythms. Alternate defibrillation waveforms may reduce energy requirements, reducing the size and weight of the device.”
Cummins R, et.al. Low-Energy Biphasic Waveform Defibrillation: Evidence-Based Review Applied to Emergency Cardiovascular Care Guidelines: A statement for healthcare professionals from the american heart association committee on emergency cardiovascular care and the subcommittees on basic life support, advanced cardiac life support, and pediatric resuscitation. <i>Circulation</i> 1998; 97:1654-1667.	“Positive evidence supports a statement that initial low-energy (150J), nonprogressive (150J-150J-150J), impedance-adjusted biphasic waveform shocks for patients in out-of-hospital VF arrest are safe, acceptable, and clinically effective.”

Related Papers and Publications	Excerpts/Conclusions
<p>American Heart Association. <i>Guidelines 2005 for Cardiopulmonary Resuscitation and Emergency Cardiovascular Care</i>. December, 2005;IV:37.</p>	<p>In reference to Biphasic Waveform Defibrillators: “Researchers have collected data from both out-of-hospital and in-hospital studies (electrophysiologic studies and implantable cardioverter-defibrillator [ICD] testing and evaluation). Overall this research indicates that lower-energy biphasic waveform shocks have equivalent or higher success for termination of VF than either damped sinusoidal or truncated exponential monophasic waveform shocks delivering escalating energy (200 J, 300 J, 360 J) with successive shocks.”</p>
<p>ECRI. External Biphasic defibrillators: Should you catch the wave? <i>Health Devices</i> 2001;30:219-225.</p>	<p>“It is likely that the optimal energy level for biphasic defibrillators will vary with the units' waveform characteristics. An appropriate energy dose for one biphasic waveform may be inappropriate for another. ... So it's necessary to refer to the supplier's recommendations to determine the proper energies to be used for a given waveform.”</p>
<p>Jordan D. The fundamentals of automated external defibrillators. <i>Biomedical Instrumentation and Technology</i> 2003;37:55-59.</p>	<p>General article about automated external defibrillators and the technology used to design and build them.</p>

Electromagnetic Interference and AED Use	Excerpts/Conclusions
<p>Fleischhackl R, Singer F, Nitsche W, Gamperl G, Roessler B, Arrich J, Fleischhackl S, Losert H, Sterz F, Mittlboeck M, Hoerauf K. Influence of electromagnetic fields on function of automated external defibrillators. <i>Acad Emerg Med</i> 2006 Jan; 13(1)1-6.</p>	<p>“ABSTRACT. OBJECTIVES In this study, the authors tested whether electromagnetic interference (EMI) is able to impair correct electrocardiogram analysis and produce false-positive shock advice from automated external defibrillators (AEDs) when the true rhythm is sinus. METHODS Nineteen healthy subjects were used to test five AEDs available on the Austrian market in a prospective, open, and sequence-randomized study. The primary outcome variable was the absolute number of shocks advised in the presence of EMI. The secondary outcome was the number of impaired analyses caused by incorrectly detected patient movements or electrode failure. RESULTS Of 760 tests run, 18 (2.37%) cases of false-positive results occurred, and two of five AEDs recommended shocks in the presence of sinus rhythm. Of 760 tests run, no electrode failures occurred. There were 27 occurrences (3.55%) of motion detected by an AED in the presence of strong electromagnetic fields. CONCLUSIONS AED models differ in their response to EMI; it may be useful to consider specific safety requirements for areas with such fields present. Working personnel and emergency medical services staff should be informed about potential risks and the possible need for patient evacuation before AEDs are attached and shock recommendations are followed.”</p>

Pediatric Defibrillation	Excerpts/Conclusions
<p>Gurnett CA, Atkins DL. Successful use of a biphasic waveform automated external defibrillator in a high-risk child. <i>Am J Cardiol</i> 2000 Nov 1;86(9):1051-3.</p>	<p>“This case report suggests that in young children, defibrillation can be accomplished and risk of myocardial damage using currently available truncated biphasic waveform defibrillation may be small.”</p>
<p>Cecchin F, Jorgenson DB, Berul CI, Perry JC, Zimmerman AA, Duncan BW, Lupinetti FM, Snyder D, Lyster TD, Rosenthal GL, Cross B, Atkins DL. Is arrhythmia detection by automatic external defibrillator accurate for children? <i>Circulation</i> 2001; 103:2483-2488.</p>	<p>“There was excellent AED rhythm analysis sensitivity and specificity in all age groups for ventricular fibrillation and nonshockable rhythms. The high specificity and sensitivity indicate that there is a very low risk of an inappropriate shock and that the AED correctly identifies shockable rhythms, making the algorithm both safe and effective for children.”</p>
<p>Atkins DL and Jorgenson DB. Attenuated pediatric electrode pads for automated external defibrillator use in children. <i>Resuscitation</i> 2005 Jul; 66(1):31-7.</p>	<p>“Voluntary reports of the use of attenuated pediatric defibrillation pads indicate the devices performed appropriately. All eight VF patients had termination of VF and five survived to hospital discharge. These data support the rapid deployment of AEDs for young children as well as adolescents and adults. Since the pediatric pads are available and deliver an appropriate dose for children, their use should be strongly encouraged.”</p>

Defibrillation and CPR	Conclusions
<p>Young C, Bisera J, Gehman S, Snyder D, Tang W, Weil MH. Amplitude spectrum area: measuring the probability of successful defibrillation as applied to human data. <i>Crit Care Med</i> 2004 Sep; 32(9 Suppl):S356-8.</p>	<p>Based on the spectral characteristics of ventricular fibrillation potentials, we examined the probability of successful conversion to an organized viable rhythm, including the return of spontaneous circulation. The incentive was to predict the likelihood of successful defibrillation and thereby improve outcomes by minimizing interruptions in chest compression and minimizing electrically induced myocardial injury due to repetitive high-current shocks... AMSA [amplitude spectral area] predicts the success of electrical defibrillation with high specificity. AMSA therefore serves to minimize interruptions of precordial compression and the myocardial damage caused by delivery of repetitive and ineffective electrical shocks</p>
<p>Snyder D and Morgan C. Wide variation in cardiopulmonary resuscitation interruption intervals among commercially available automated external defibrillators may affect survival despite high defibrillation efficacy. <i>Crit Care Med</i> 2004 Sep; 32(9 Suppl):S421-4.</p>	<p>In addition to defibrillation waveform and dose, researchers should consider the hands-off cardiopulmonary resuscitation interruption interval between cardiopulmonary resuscitation and subsequent defibrillation shock to be an important covariate of outcome in resuscitation studies. Defibrillator design should minimize this interval to avoid potential adverse consequences on patient survival. See Selected Clinical Studies at the end of this chapter for a more detailed discussion of this publication.</p>

Defibrillation and CPR	Conclusions
Snyder DE, White RD, Jorgenson DB. Outcome prediction for guidance of initial resuscitation protocol: Shock first or CPR first. <i>Resuscitation</i> 2007; 72:45-51.	Both call-to-shock interval and a real-time ECG analysis are predictive of patient outcome. The ECG analysis is more predictive of neurologically intact survival. Moreover, the ECG analysis is dependent only upon the patient's condition at the time of treatment, with no need for knowledge of the response interval, which may be difficult to estimate at the time of treatment.

AED Use and Rescuer Safety	Excerpts/Conclusions
Lyster T, Jorgenson D, and Morgan C. The safe use of automated external defibrillators in a wet environment. <i>Prehosp Emerg Care</i> 2003 Jul-2003 Sep 30; 7(3)307-11	<p>“ABSTRACT There has been concern regarding potential shock hazards for rescuers or bystanders when a defibrillator is used in a wet environment and the recommended safety procedure, moving the patient to a dry area, is not followed. OBJECTIVE To measure the electrical potentials associated with the use of an automated external defibrillator (AED) in a realistically modeled wet environment. METHODS A raw processed turkey was used as a patient surrogate. The turkey was placed on a cement floor while pool water was applied to the surrounding area. To simulate a rescuer or bystander in the vicinity of a patient, a custom sense probe was constructed. Defibrillation shocks were delivered to the turkey and the probe was used to measure the voltage an operator/bystander would receive at different points surrounding the surrogate. The test was repeated with salt water. RESULTS The maximum voltage occurred approximately 15 cm from the simulated patient and measured 14 V peak (current 14 mA peak) in the case of pool water, and 30 V peak (current 30 mA peak) in the case of salt water. CONCLUSIONS Thirty volts may result in some minor sensation by the operator or bystander, but is considered unlikely to be hazardous under these circumstances. The maximum currents were lower than allowed by safety standards. Although defibrillation in a wet environment is not recommended practice, our simulation of a patient and a rescuer/bystander in a wet environment did not show significant risk should circumstances demand it.”</p>

AED Use by Lay Rescuers	Excerpts/Conclusions
Gundry JW, Comess KA, DeRook FA, Jorgenson D, Bardy GH. Comparison of naïve sixth-grade children with trained professionals in the use of an automated external defibrillator. <i>Circulation</i> 1999; 100:1703-1707.	“During mock cardiac arrest, the speed of AED use by untrained children is only modestly slower than that of professionals. The difference between the groups is surprisingly small, considering the naivete of the children as untutored first-time users.”

AED Use by Lay Rescuers	Excerpts/Conclusions
Page RL, Joglar JA, Kowal RC, Zagrodzky JD, Nelson LL, Ramaswamy K, Barbera SJ, Hamdan MH, McKenas DK. Use of automated external defibrillators by a U.S. airline. <i>N Engl J Med</i> 2000 Oct 26; 343(17):1210-6.	“The use of the automated external defibrillator aboard commercial aircraft is effective, with an excellent rate of survival to discharge from the hospital after conversion of ventricular fibrillation. There are not likely to be complications when the device is used as a monitor in the absence of ventricular fibrillation.”
Capucci A, Aschieri D, Piepoli MF, Bardy GH, Iconomu E, Arvedi M. Tripling survival from sudden cardiac arrest via early defibrillation without traditional education in cardiopulmonary resuscitation. <i>Circulation</i> 2002 Aug 27; 106(9):1065-70.	“Broad dissemination of AEDs for use by nonmedical volunteers enabled early defibrillation and tripled the survival rate for out-of-hospital SCA.”
Caffrey SL, Willoughby PJ, Pepe PE, Becker LB. Public use of automated external defibrillators. <i>N Engl J Med</i> 2002 Oct 17; 347(16):1242-7.	“Automated external defibrillators deployed in readily accessible, well-marked public areas in Chicago airports were used effectively to assist patients with cardiac arrest. In the cases of survivors, most of the users had no duty to act and no prior training in the use of these devices“
Jorgenson DB, Skarr T, Russell JK, Snyder DE, Uhrbrock K. AED use in businesses, public facilities and homes by minimally trained first responders. <i>Resuscitation</i> 2003 Nov; 59(2):225-33.	“This survey demonstrates that AEDs purchased by businesses and homes were frequently taken to suspected cardiac arrests. Lay responders were able to successfully use the AEDs in emergency situations. Further, there were no reports of harm or injury to the operators, bystanders or patients from lay responder use of the AEDs.”
Capucci A and Aschieri D. [Early defibrillation in the treatment of sudden cardiac arrest]. <i>Recenti Prog Med</i> 2003 Jun; 94(6):241-6.	“Improvement in in-hospital survival rates from cardiac arrest is not as evident as in the emergency medical service community. Medical centers need to assess response times to cardiac arrest and implement AED programs. All the nurses should learn to use an AED as part of basic life support training.“
Andre AD, Jorgenson DB, Froman JA, Snyder DE, Poole JE. Automated external defibrillator use by untrained bystanders: Can the public-use model work? <i>Prehospital Emergency Care</i> 2004; 8:284-291.	“This study demonstrated that the AED user interface significantly influences the ability of untrained caregivers to appropriately place pads and quickly deliver a shock. Avoiding grossly inappropriate pad placement and failure to place AED pads directly on skin may be correctable with improvements in the AED instruction user interface.”

Ease of Use and User-Interface Studies	Excerpts/Conclusions
<p>Eames P, Larson PD, Galletly DC. Comparison of ease of use of three automated external defibrillators by untrained lay people. <i>Resuscitation</i> 2003 Jul; 58(1):25-30.</p>	<p>“Zoll AEDPlus, Medtronic Physio-Control LifePak CR Plus and Philips/Laerdal HeartStart OnSite Defibrillator. Subjects' performance were videotaped and reviewed for time to defibrillate, pad positioning and safety. Subjects were asked to rate the three units in terms of ease-of-use. Average times to first shock were 74.8 s for the Physio-Control, 83.0 s for the Laerdal and 153.4 s for the Zoll defibrillator. Pad positioning was scored as correct in 23/24 Laerdal trials, 19/24 Physio-Control trials and 14/24 Zoll trials. 23 out of the 24 subjects rated the Zoll most difficult to use. All subjects safely stayed clear of the unit when required. The majority of subjects safely and effectively delivered defibrillating shocks without any prior training and within quite acceptable times. Untrained subjects find the Physio-Control and Laerdal Defibrillator easier to use than the Zoll device.”</p>
<p>Nurmi J, Rosenberg P, Castren M. Adherence to guidelines when positioning the defibrillation electrodes. <i>Resuscitation</i> 2004 May; 61(2):143-7.</p>	<p>“Professionals were recruited from emergency medical services, university hospitals and primary care. Not revealing the purpose of the test, participants were asked to place self-adhesive electrodes on a manikin as they would do in the resuscitation situation and to answer a questionnaire about resuscitation training and familiarity with the guidelines... The publication of the national evidence based resuscitation guidelines did not seem to have influenced the practice of placement of the defibrillation electrodes to any major extent. The correct placement of the electrodes needs be emphasized more in the resuscitation training”</p>

Ease of Use and User-Interface Studies	Excerpts/Conclusions
<p>Fleischhackl R, Losert H, Haugk M, Eisenburger P, Sterz F, Laggner A N, Herkner H. Differing operational outcomes with six commercially available automated external defibrillators. <i>Resuscitation</i> 2004 Aug; 62(2):167-74.</p>	<p>“Electrodes were not attached correctly in nine cases (4 Power Heart, 2 AED+, 2 Access, 1 CR+). Volunteers stated that they were confused about the electrode positioning in 12 cases (5 Power Heart, 3 Access, 2 Fred easy®, 2 CR+ 1 AED+) but placed the pads correctly. In two cases the lay rescuers did not remove the plastic liner from the pads (1 Power Heart, 1 AED+). Two volunteers in the AED+ group did not remove clothing from the manikin's chest before attaching the electrodes. The information button provided by the HSI was pressed by all users (15 out of 15) to be guided through BLS...</p> <p>“HSI (Philips Medical Systems, Andover, Seattle, USA) This device guides the user with slow and clear prompts. Users stated that the different signed electrodes of this device were useful. It also provides an information button to get further instruction as to how to start and provide BLS. All users pressed this button and did exactly what the device prompted. The recommended heart compression rate given by a metronome was appreciated by the volunteers. Mouth to mouth ventilation was explained precisely as well as chest compression...</p> <p>...there are significant differences between AEDs, concerning important operational outcomes like time to first shock and the start of BLS [basic life support]. Further research and development is urgently required to optimise user-friendliness and operational outcomes.”</p>
<p>Callejas S, Barry A, Demertsidis E, Jorgenson D, Becker LB. Human factors impact successful lay person automated external defibrillator use during simulated cardiac arrest. <i>Crit Care Med</i> 2004 Sep;32 (9 Suppl): S406-13.</p>	<p>“Both devices [Philips FR2 or HSI] are safe with either video-trained or naive users. The successful use of each device is high when participants view the training videotape designed for the device. Collectively, these data support the notion that human factors associated with ease of use may play a critical factor in survival rates achieved by specific devices.</p>
<p>Nurmi J and Castren M. Layperson positioning of defibrillation electrodes guided by pictorial instructions. <i>Resuscitation</i> 2005 Feb; 64(2):177-80.</p>	<p>“Defibrillation electrodes from five manufacturers (Access Cardio Systems, Schiller, Medtronic, Cardiac Science and Philips) were included in the study and compared with electrodes with a lateral view picture, designed for the study, showing the placement of the apical electrode... The current practice in designing pictures on the electrodes does not seem to be optimal in showing the recommended position of the apical electrode as recommended by Guidelines 2000. It is suggested that by showing a lateral view in the instructions, success in placing the apical electrodes correctly can be improved.” [NOTE: All Philips AED pads use a lateral view for the apical pad.]</p>

Ease of Use and User-Interface Studies	Excerpts/Conclusions
<p>Cappato R, Curnis A, Marzollo P, Mascioli G, Bordonali T, Beretti S, Scalfi F, Bontempi L, Carolei A, Bardy G, De Ambroggi L, Dei Cas L. Prospective assessment of integrating the existing emergency medical system with automated external defibrillators fully operated by volunteers and laypersons for out-of-hospital cardiac arrest: the Brescia Early Defibrillation Study (BEDS). <i>Eur Heart J</i> 2006 Mar; 27(5):553-61.</p>	<p>“Diffuse implementation of AEDs fully operated by trained volunteers and laypersons within a broad and unselected environment proved safe and was associated with a significantly higher long-term survival of CA [cardiac arrest] victims.“</p>

SELECTED STUDY SUMMARIES

The following summaries of published study results are provided to illustrate important technological advantages of the Philips HeartStart automated external defibrillators.

HEARTSTART LOW-ENERGY, HIGH-CURRENT DESIGN

SUMMARY OF: Wanchun Tang, MD; Max Harry Weil, MD, PHD; Shijie Sun, MD; Dawn Jorgenson, PHD; Carl Morgan, MSEE; Kada Klouche, MD; David Snyder, MSEE. The effects of biphasic waveform design on post-resuscitation myocardial function. *JACC* 2004 Apr 7; 43, (7) 1228-35.

Introduction

This study, supported in part by grants from NIH National Heart, Blood and Lung Institute, the American Heart Association, and Philips Medical Systems, examined the effects of biphasic truncated exponential waveform design on survival and post-resuscitation myocardial function after prolonged ventricular fibrillation (VF).

Background

It has been established that biphasic waveforms are more effective than monophasic waveforms for successful defibrillation, but optimization of energy and current levels to minimize post-resuscitation myocardial dysfunction has been largely unexplored. A biphasic truncated exponential (BTE) waveform may be designed to minimize the defibrillation threshold in terms of either energy or peak current but these two notions of optimization result in different waveform shapes.

Using two biphasic waveforms commonly available in commercial products — a low-capacitance waveform typical of low-energy application (low-energy biphasic truncated exponential [BTEL]; 100 μ F, 100-200 J) and a high-capacitance waveform typical of high-energy application (high-energy biphasic truncated exponential [BTEH]; 200 μ F, 200-360 J) — this study examined resuscitation outcomes after seven minutes of untreated ventricular fibrillation.

Methods

Four groups of anesthetized 40- to 45-kg pigs were investigated. After 7 minutes of electrically induced ventricular fibrillation, a 15-minute resuscitation attempt was made using sequences of up to 3 defibrillation shocks followed by 1 minute of cardiopulmonary resuscitation. Animals were randomized to BTEL at 150 J or 200 J or to BTEH at 200 J or 360 J.

Results and Discussion

A significant overall effect was detected for survival as a function of waveform. All animals were successfully resuscitated after delivery of BTEL 150-J or 200-J shocks as well as with BTEH 360-J shocks. However, only two of five animals were successfully resuscitated after BTEH 200-J shocks. All resuscitated animals survived for more than 72 h, with no differences in neurological alertness score among the four groups. Animals treated with BTEL shocks required fewer shocks, less CPR, and less total energy to resuscitate than animals treated with BTEH.

Myocardial function, as judged by hemodynamic performance, was reduced in all animals after successful resuscitation. Although post-resuscitation hemodynamics continuously improved over time, substantial deficits were still apparent in animals treated with higher-energy shocks at the conclusion of the 4-hour observation period.

The study confirmed that biphasic waveform defibrillation with a BTEL waveform at 150 J is as effective as the same waveform at 200 J and as effective as BTEH shocks at 360 J for successful return of spontaneous circulation, with the additional benefit of minimizing post-resuscitation myocardial dysfunction. Less than half the subjects treated with BTEH shocks at 200 J were resuscitated.

These effects are attributable to specific characteristics of waveform design. In particular, higher peak current is positively associated with improved survival, whereas higher energy and higher average current are associated with increased post-resuscitation myocardial dysfunction. Post-resuscitation myocardial dysfunction has been associated with early death after initial successful resuscitation. Earlier studies have shown that the severity of post-resuscitation myocardial dysfunction is closely related to the duration of cardiac arrest, treatment with betaadrenergic agents, and the severity of hypercarbic myocardial acidosis. Further, the total electrical energy delivered during defibrillation attempts has been shown to be related to the severity of post-resuscitation myocardial dysfunction and survival in both rat and pig models.

Conclusions

This study demonstrated that for biphasic truncated exponential waveforms representative of commercial implementations, peak electrical current is the primary factor in survival. Maximum survival and minimum myocardial dysfunction were observed with the low capacitance 150-J waveform, which delivered higher peak current while minimizing energy and average current. These findings suggest that peak current is a more appropriate measure of defibrillation dose than either energy or average current. Furthermore, these conclusions suggest that post-resuscitation myocardial dysfunction is related to a cumulative, as opposed to an instantaneous, electrical exposure mechanism.

HEARTSTART QUICK SHOCK FEATURE

SUMMARY OF: Wanchun Tang, MD; David Snyder, MSEE; Jinglan Wang, MD, PhD; Lei Huang, MD; Yun-Te Chang, MD; Shijie Sun, MD; Max Harry Weil, MD, PhD. One-shock versus three-shock defibrillation protocol significantly improves outcome in a porcine model of prolonged ventricular fibrillation cardiac arrest. *Circulation*. 2006 June 13; 113(23)2683-9.

Introduction

This study, funded by Philips Medical Systems and the American Heart Association, was undertaken in response to suggestions by previous clinical studies that AED-imposed interruptions of cardiopulmonary resuscitation (CPR) occurring after initial defibrillation shocks may adversely affect patient outcomes.

These concerns had been corroborated in laboratory experiments, especially with respect to the interval required for automated rhythm analysis and defibrillator charging between CPR and defibrillation shock.

Background

This study examined the hypothesis that wide variations in AED design, especially with respect to CPR interruption intervals, have a significant impact on resuscitation success. It also tested the hypothesis that a new one-shock defibrillation protocol designed to increase the percentage of time devoted to ventilation and circulatory support would improve resuscitation outcomes and minimize the impact of AED design variations.

Methods

Of seven commercially available automated AEDs whose CPR interruption intervals were measured in a separate study, the energy delivery regimen of the fastest and slowest two devices were selected for use in configuring the manual defibrillators for this study. The manual defibrillators were manufactured by the same companies and delivered the same waveforms as the corresponding AEDs. Both waveforms are impedance compensating but differ significantly in other aspects, with AED1 a low-energy (150 J) device using a 100 μ F capacitor, and AED2 an escalating energy (200-300-360 J) device using a 200 μ F capacitor.

Cardiac arrest was induced in adult male pigs randomized to each of four groups by AED regimen and defibrillation protocol: low-energy, single-shock; low-energy, up to three shocks; high energy, single shock; and high energy, up to three shocks. After seven minutes of untreated ventricular fibrillation (VF), resuscitation was attempted using an initial sequence of one or up to three sequential shocks. If resuscitation using defibrillation was unsuccessful,

compressions were performed for 60 seconds and mechanical ventilation was provided.

Primary observations included success of initial resuscitation, 72-hour post-resuscitation survival, and post-resuscitation myocardial function characterized by left ventricular ejection fraction and stroke volume.

Results

The study found that adoption of a one-shock defibrillation protocol successfully increased the percentage of time during which subjects received CPR during a resuscitation attempt compared with a three-shock protocol, thereby reducing post-resuscitation myocardial dysfunction and increasing survival. It also demonstrated that with a three-shock protocol, design variations among currently available AEDs have a significant impact on resuscitation success, despite similar defibrillation efficacy. Importantly, the one-shock protocol was also found to minimize the impact of AED-imposed treatment variations.

PHILIPS MEDICAL SYSTEMS

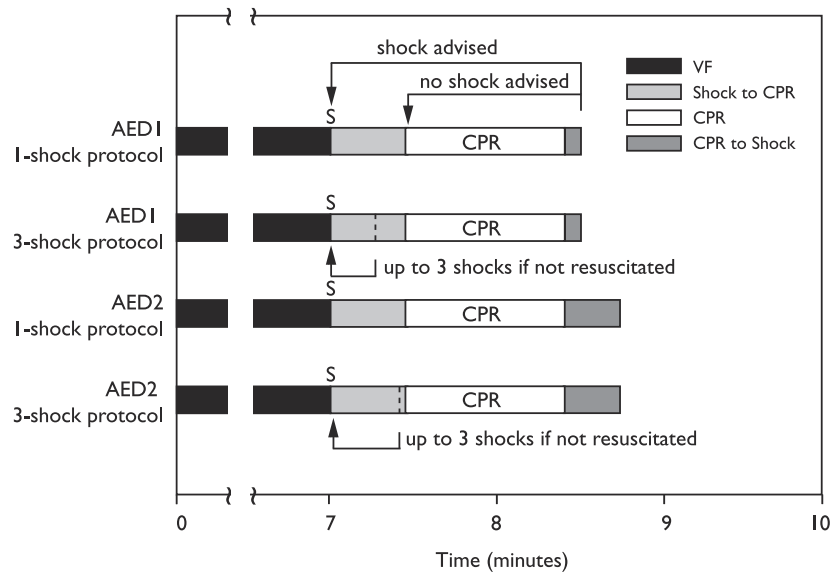

Outcome

With long downtime cases of cardiac arrest, providing continuous, quality CPR, especially chest compressions, is an extremely important factor in successful resuscitation. Experimental and clinical studies have shown that interruption of chest compressions for as little as 10 seconds between each interval of CPR for rhythm analysis, ventilation, or patient assessment significantly reduces the number of chest compressions delivered to a patient. This results in a reduction of coronary perfusion pressure and myocardial blood flow and decreases the likelihood of successful resuscitation. In addition, fewer chest compressions increases the severity of

post-resuscitation myocardial and cerebral dysfunction in subjects who survive.

This finding is especially important with regard to AEDs, because most currently available AEDs require significantly longer than 10 seconds for rhythm analysis and charging. CPR interruptions are prolonged even further when the three-shock protocol is used. It is clear that the performance of a defibrillator must be viewed in a much larger context than its efficacy at terminating VF. In addition to such efficacy, an optimal defibrillator must minimize interruptions of CPR for voice prompts, rhythm analysis, and capacitor charging.

Of additional significance, myocardial function was reduced in all animals after successful resuscitation, with the degree of impairment significantly dependent on choice of AED but not shock protocol. For the same shock protocol, AED1 always produced significantly less myocardial dysfunction than did AED2.

Both left ventricular ejection fraction and stroke volume were better after treatment with AED1 compared with AED2, but neither was significantly affected by shock protocol. Stroke volume continuously improved over time, but at the end of the four-hour observation period, substantial deficits were still apparent in animals treated with AED2 combined with a three-shock protocol and not in the other treatment groups. Ejection fraction did not show much improvement over the four-hour observation period for both AED2 and a three-shock protocol.

Mean aortic pressure and cardiac output did not differ significantly between groups, being compensated for by higher observed heart rates in the groups with decreased left ventricular volumes (Table 4). Myocardial function for all surviving animals returned to baseline by the end of the 72-hour observation period

Conclusions

In conclusion, the present study demonstrated that when a conventional three-shock defibrillation protocol was used, design variations among commercially available AEDs had a significant impact on the initial success of resuscitation, post-resuscitation myocardial dysfunction, and 72-hour survival after prolonged VF. Adoption of a one-shock protocol, however, improved initial resuscitation and survival. Post-resuscitation myocardial dysfunction was less pronounced with the low-energy waveform, independent of shock protocol.

HEARTSTART HUMAN FACTORS DESIGN

SUMMARY OF: Roman Fleischhackl, Heidrun Losert, Moritz Haugk, Philip Eisenburger, Fritz Sterz, Anton N. Laggner and Harald Herkner. Differing operational outcomes with six commercially available automated external defibrillators. *Resuscitation*. 2004 Aug; 62(2)167-74.

Introduction

Many out-of-hospital cardiac arrest victims suffer from mild to severe, very often irreversible, neurological damage. Neurological impairment in survivors of sudden cardiac arrest can be decreased by effective early resuscitation by lay or professional rescuers. The success of out-of-hospital cardiopulmonary resuscitation (CPR) depends largely on the elapsed time between victim collapse and the provision of help by a bystander witness. Most citizens worry about making mistakes in bystander CPR, and therefore hesitate to provide immediate support. Automated external defibrillators (AEDs) can potentially help to quell such anxieties and thus decrease the time to shock delivery and subsequent provision of basic life support (BLS).

Although AEDs are designed to be easy to use, design solutions vary by device and manufacturer, and untrained lay rescuers may have significant problems using particular products. Instructions for AEDs must be unambiguous and intuitive in order to promote time-critical action. Cultural distinctions may affect comprehension of specific visual and linguistic instructions. Since most AEDs are produced by international companies for use in many countries, technical solutions, guiding figures, and voice prompts must allow for cultural differences to help ensure that lay rescuers are not confused by AED instructions and delay taking action. In addition, device design should take into account varying light conditions as well as the possibility of loud or distracting noise in the environment of use.

To study the effect of voice prompts and design solutions, we tested six AEDs commercially available in Austria for the time to delivery of the first shock and from first-shock delivery to the initiation of BLS.

Methods

Ninety volunteers consented to participate, and all of those who consented completed the experiment. The volunteers had no AED training. They were randomized into six groups and assigned an AED trainer device that mimicked the behavior of a corresponding AED model (Figure 1).

The scene of the experiment was a semi-public place comparable to the environment of a shopping mall. The only direction given the volunteers was that they would be exposed to a simulated cardiac arrest situation and that they should attempt every action that they would consider to be helpful. The “victim” was a dressed manikin, and volunteers were provided with the AED trainer, a face shield, and latex gloves.



Figure 1. Top row, left to right: LIFEPAK CRT™ (Medtronic, Minneapolis, USA), Fred easy® (Schiller AG, Baar, Switzerland), AED+ PLUS™ (Zoll Medical, Chelmsford, Massachusetts USA); bottom row, left to right: Access™ (Access Cardio Systems, Concord, Massachusetts, USA), Power Heart Training Unit™ (Cardiac Science Inc., Irvine, California, USA), and HSI™ (Philips Medical System, Andover, Seattle, USA).

The volunteers were then evaluated to see when they delivered the first shock (measured in seconds) and whether they started BLS after the first shock. Instances of poorly positioned electrodes, misunderstood voice prompts, and other difficulties or events were also recorded.

Results

The outcomes for both time to first shock delivery and first shock delivery to initiation of BLS care varied significantly by AED. Time to first shock delivered ranged from 78 to 128 seconds (Figure 2). The proportion of volunteers who

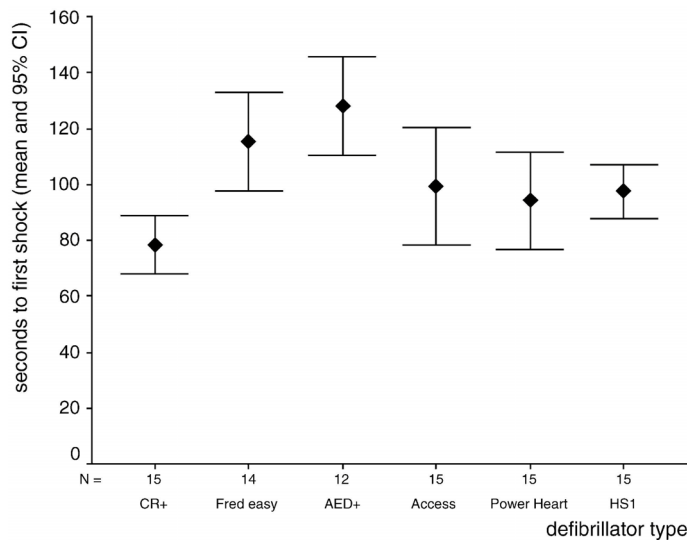

Figure 2. Defibrillator type and the time to first shock (seconds, mean and 95% CI). In three occasions with AED+™ and in one occasion with Fred easy® volunteers failed to deliver a shock.

started BLS after defibrillation ranged from 93 to 33% (Figure 3).

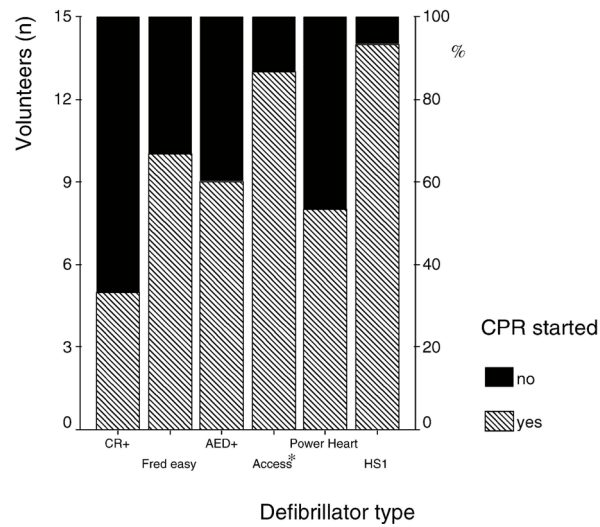

Figure 3. The number of volunteers who started BLS after shock according to the defibrillator used in random order. Access had limited comparability to other defibrillators, because the training-device had to be turned off after the last voice prompt.

Electrodes were not attached correctly in 9 cases (4 Power Heart, 2 AED+, 2 Access, 1 CR+). Volunteers stated that they were confused about the electrode positioning in 14 cases (5 Power Heart, 3 Access, 2 Fred easy, 2 CR+, 1 AED+) but placed the pads correctly. In two cases the lay rescuers did not remove the plastic liner from the pads (1 Power Heart, 1 AED+). Two volunteers in the AED+ group did not remove clothing from the manikin's chest before attaching the electrodes.

Regarding the HeartStart HSI AED, the study authors noted: "This device guides the user with slow and clear prompts. Users stated that the different signed electrodes of this device were useful. It also provides an information button to get further instruction as to how to start and provide BLS. All users pressed this button and did exactly what the device prompted. The recommended heart compression rate given by a metronome was appreciated by the volunteers. Mouth to mouth ventilation was explained precisely as well as chest compression."

Conclusions

This study demonstrated that there are significant differences between AED human factor design solutions that affect important operational outcomes like time to first shock and the start of BLS.

HEARTSTART DEFIBRILLATION THERAPY TESTING IN ADULT VICTIMS OF OUT-OF-HOSPITAL CARDIAC ARREST

SUMMARY OF: Schneider T, Martens PR, Paschen H, Kuisma M, Wolcke B, Gliner BE, Russell JK, Weaver WD, Bossaert L, Chamberlain D. Multicenter, randomized, controlled trial of 150-J biphasic shocks compared with 200- to 360-J monophasic shocks in the resuscitation of out-of-hospital cardiac arrest victims. *Circulation* 2000 Oct 10; 102(15): 1780-7.

Introduction

The HeartStart FR2 utilizes the patented SMART Biphasic waveform. This waveform has been extensively tested in pre-clinical and both electrophysiology laboratory and out-of-hospital clinical studies. The following information summarizes the results of a large study comparing the use of SMART Biphasic AEDs to conventional monophasic in out-of-hospital emergency resuscitation situations.

Background

Heartstream conducted an international, multicenter, prospective, randomized clinical study to assess the effectiveness of the SMART Biphasic waveform in out-of-hospital sudden cardiac arrests (SCAs) as compared to monophasic waveforms. The primary objective of the study was to compare the percent of patients with ventricular fibrillation (VF) as the initial monitored rhythm that were defibrillated in the first series of three shocks or fewer.

Methods

Victims of out-of-hospital SCA were prospectively enrolled in four emergency medical service (EMS) systems. Responders used either 150 J SMART Biphasic AEDs or 200-360 J monophasic waveform AEDs. A sequence of up to three defibrillation shocks was delivered. For the biphasic AEDs there was a single energy output of 150 J for all shocks. For monophasic AEDs, the shock sequence was 200-200-360 J. Defibrillation was defined as termination of VF for at least five seconds, without regard to hemodynamic factors.

Results

Randomization to the use of monophasic or SMART Biphasic AEDs was done in 338 SCAs from four emergency medical service systems. VF was observed as the first monitored rhythm in 115 patients. The biphasic and monophasic groups for these 115 patients were similar in terms of age, sex, weight, primary structural heart disease, cause and location of arrest, and bystanders witnessing the arrest or performing CPR. The average time from call to first shock was 8.9 ± 3 minutes.

The 150 J SMART Biphasic waveform defibrillated 96% of VF patients in the first shock and 98% of VF patients in the first series of three shocks or fewer compared with 69% of patients treated with monophasic waveform shocks. Outcomes are summarized as follows:

	SMART Biphasic patients number (%)	monophasic patients number (%)	P value (chi square)
defibrillation efficacy:			
single shock only	52/54 (96%)	36/61 (59%)	<0.0001
</= 2 shocks	52/54 (96%)	39/61 (64%)	<0.0001
</= 3 shocks	53/54 (98%)	42/61 (69%)	<0.0001
patients defibrillated	54/54 (100%)	49/58 (84%)	0.003
rosc	41/54 (76%)	33/61 (54%)	0.01
survival to hospital admission	33/54 (61%)	31/61 (51%)	0.27
survival to hospital discharge	15/54 (28%)	19/61 (31%)	0.69
cpc = 1 (good)	13/15 (87%)	10/19 (53%)	0.04

Conclusions

The 150 J SMART Biphasic waveform defibrillated at higher rates than the 200-360 J monophasic waveforms, resulting in more patients achieving return of spontaneous circulation (ROSC) ($p=0.01$). EMS system outcomes of survival discharge were not significantly different statistically. However, patients resuscitated with the lower-energy SMART Biphasic waveform were more likely to have good cerebral performance (CPC, cerebral performance category) ($p=0.04$).

HEARTSTART PATIENT ANALYSIS SYSTEM TESTING WITH PEDIATRIC RHYTHMS

SUMMARY OF: Cecchin F, Jorgenson DB, Berul CI, Perry JC, Zimmerman AA, Duncan BW, Lupinetti FM, Snyder D, Lyster TD, Rosenthal GL, Cross B, Atkins DL. Is arrhythmia detection by automatic external defibrillator accurate for children? *Circulation*. 2001; 103:2483-2488.

Background

Heartstream sponsored a multicenter study to develop an ECG database of shockable and non-shockable rhythms from a broad range of pediatric patients and then test the accuracy of the HeartStart Patient Analysis System (PAS) for sensitivity and specificity with those rhythms.

Methods

Two sources were used for the database: (1) RECORDED DATA, a clinical study where rhythms were recorded from pediatric patients via a modified ForeRunner AED and (2) DIGITIZED DATA, a collection of infrequently observed shockable pediatric rhythms, solicited from pediatric electrophysiologists worldwide, that had been captured on paper and were subsequently digitized. The study resulted in a database of 697 rhythm segments from 191 patients, collected from four investigational sites. The children were divided into three groups according to age: up to 1 year, greater than 1 year and less than 8 years and 8 years through 12 years. The demographic characteristics for the three groups are displayed in Tables 1 and 2 for the recorded and digitized groups, respectively. Patient enrollment was initiated on October 2, 1998, and patient enrollment concluded on August 28, 1999.

Table 1. Recorded Rhythms

age group (n)	median age (range)	median weight (range)	gender (m/f)
≤1 year (59)	90 days (1 day–1 yr)	4.7 kg (2.1–10.1 kg)	40/19
>1 <8 years (40)	3 yrs (1.1–7 yrs)	15.5 kg (7.6–38.0 kg)	20/20
≥8 ≤12 years (35)	9 yrs (8–12 yrs)	34.2 kg (22.0–70.7 kg)	21/14
Total (134)	1.8 yrs	10.0 kg	81/53

Table 2. Digitized Rhythms

age group (n)	median age (range)	median weight (range)	gender (m/f)
≤1 year (15)	0.5 yr (16 days – 1 yr)	6.8 kg (3.0-9.1 kg)	7/8
>1 <8 years (22)	5.0 yrs (1.2-7.7 yrs)	16.8 kg (10-31 kg)	10/12
≥8 ≤12 years (20)	10.9 yrs (8-12 yrs)	43 kg (24-61.4 kg)	12/8
Total (57)	6.0 yrs	18.0 kg	29/28

Results

The results of this study are provided in Table 3. The “AHA goal” columns refer to the American Heart Association's performance goals for AED algorithms, which were established for adults. Although the scope of these performance goals does not apply to pediatric patients, the values are provided here for reference.

Table 3. Pooled Rhythms Sensitivity and Specificity n(%) and Lower Confidence Limits

rhythm	sensitivity	specificity	AHA goal	90% one-sided LCL*	AHA LCL goal
VF	73 (95.9%)	NA	>90%	91.1%	87%
VT, rapid	58 (70.7%)	NA	>75%	61.7%	67%
SR	NA	173 (100%)	>99%	98.7%	97%
SVA	NA	116 (100%)	>95%	98.0%	88%
VEB	NA	95 (100%)	>95%	97.6%	88%
idio	NA	40 (100%)	>95%	94.4%	88%
asystole	NA	39 (100%)	>95%	94.3%	92%

* Armitage P and Berry G, *Statistical Methods in Medical Research*, Blackwell Scientific Publications, 2nd edition, 1987.

This study demonstrated that the HeartStart PAS has excellent sensitivity to pediatric VF rhythms (95.9%), and excellent specificity for all non-shockable rhythms (100%). The AHA sensitivity and specificity performance goals as stated for adult patients were met in all pediatric rhythm categories except for rapid VT, where sensitivity is slightly lower (70.7% vs. 75%). Although the adult performance goal was missed for this group, a conservative approach in this rhythm category for pediatric patients is appropriate due to both the higher uncertainty of association of pediatric tachycardias with cardiac arrest, and the low rate of presenting VT occurrence in the out-of-hospital setting. Further, non-perfusing tachycardias are likely to rapidly degenerate into VF. With regard to the intermediate rhythm group in which the benefits of defibrillation are limited or uncertain, the PAS was appropriately conservative, tending not to advise shocks. Importantly, these data show that the PAS is highly unlikely to inappropriately shock a pediatric rhythm. This is important in light of safety concerns for the use of an automated external defibrillator with children. This study indicates that the HeartStart Patient Analysis System can be used safely and effectively for both adults and children.

HEARTSTART DEFIBRILLATION THERAPY TESTING IN A PEDIATRIC ANIMAL MODEL

SUMMARY OF: Tang, W.; Weil, M. H.; Jorgenson, D.; Klouche, K.; Morgan, C.; Yu, T.; Sun, S., and Snyder, D. Fixed-energy biphasic waveform defibrillation in a pediatric model of cardiac arrest and resuscitation. *Crit Care Med.* 2002 Dec; 30(12):2736-41

Background

The FR2 AED with attenuated defibrillation pads delivers at least a 2 J/kg dose in the intended patient population, based on United States Center for Disease Control growth charts. Two animal studies were conducted to demonstrate the safety and effectiveness of the Heartstream biphasic waveform at 50 J in a pediatric animal model across the weight range of the intended patient population.

Methods

The first study utilized a research AED capable of delivering the Heartstream impedance-compensating biphasic waveform at a 50 J energy setting in 20 pigs in four weight categories ranging from 3.5 to 25 kg and corresponding to weights of human newborn, six month, three year and eight year old patients. The pigs in the smallest group were just over two weeks old. The second study utilized prototype attenuated electrodes with an FR2 AED in nine additional animals in three of the weight categories, including 3.5 and 25 kg weight groups. In both studies, VF was induced in the pigs, and allowed to be sustained for seven minutes prior to delivery of up to three shocks using a fixed 50 J Heartstream biphasic waveform.

A porcine model was used for these studies, because the chest configuration, anatomy and physiology of the porcine cardiovascular and pulmonary systems are similar to humans. In addition, prior studies have shown that pigs require higher energy dose per kilogram than humans and therefore they present a good “worst case” model for defibrillation effectiveness.

Results

In both studies, all animals across all weight categories were successfully resuscitated with fixed, 50 J Heartstream biphasic shocks, and all survived for the duration of the follow-up period (up to 72 hours). The results showed that the delivered peak currents were close to those expected for human pediatric patients. These studies showed no difference in hemoglobin and oxyhemoglobin, blood gas measurements, arterial lactate, end-tidal CO₂, pulmonary artery pressure, right atrium pressure, calculated coronary perfusion pressure and neurological alertness among the groups prior to arrest and after successful resuscitation. There was no difference in post-resuscitation myocardial function as measured by echocardiographic ejection fraction and fractional area change among the groups. Stroke

volume, cardiac output and left ventricular volumes returned to baseline values within 120 minutes after successful resuscitation in all groups.

These studies demonstrated that fixed 50 J Heartstream biphasic waveform shocks successfully resuscitated pigs ranging from 3.5 to 25 kg regardless of weight. All animals survived and there was no evidence of compromised post-resuscitation systolic or diastolic myocardial function.

INTENTIONALLY BLANK



Philips Healthcare is part of
Royal Philips

Philips Healthcare

United States

Philips Medical Systems
22100 Bothell Everett Highway
Bothell, WA 98021-8431, USA
(800) 263-3342

Canada

Philips Healthcare, a Division of Philips Electronics Ltd.
281 Hillmount Road
Markham, Ontario
L6C 2S3 Canada
(800) 291-6743

Europe, Middle East, and Africa

Philips Medizin Systeme Boeblingen GmbH
Cardiac and Monitoring Systems
Hewlett-Packard Strasse 2
71034 Boeblingen, Germany
(+49) 7031 463-2254

Latin America

Philips Medical Systems Ltda.
Av. Dr. Marcos Penteado Ulhôa Rodrigues, 401
Parte 16 – 06460-040 – Barueri/SP, Brazil
0800 7017789

Asia Pacific

Philips Electronics Hong Kong Ltd.
6/F, Core Building I
I Science Park East Avenue
Hong Kong Science Park
Shatin, New Territories, Hong Kong
(852) 2821 5888